

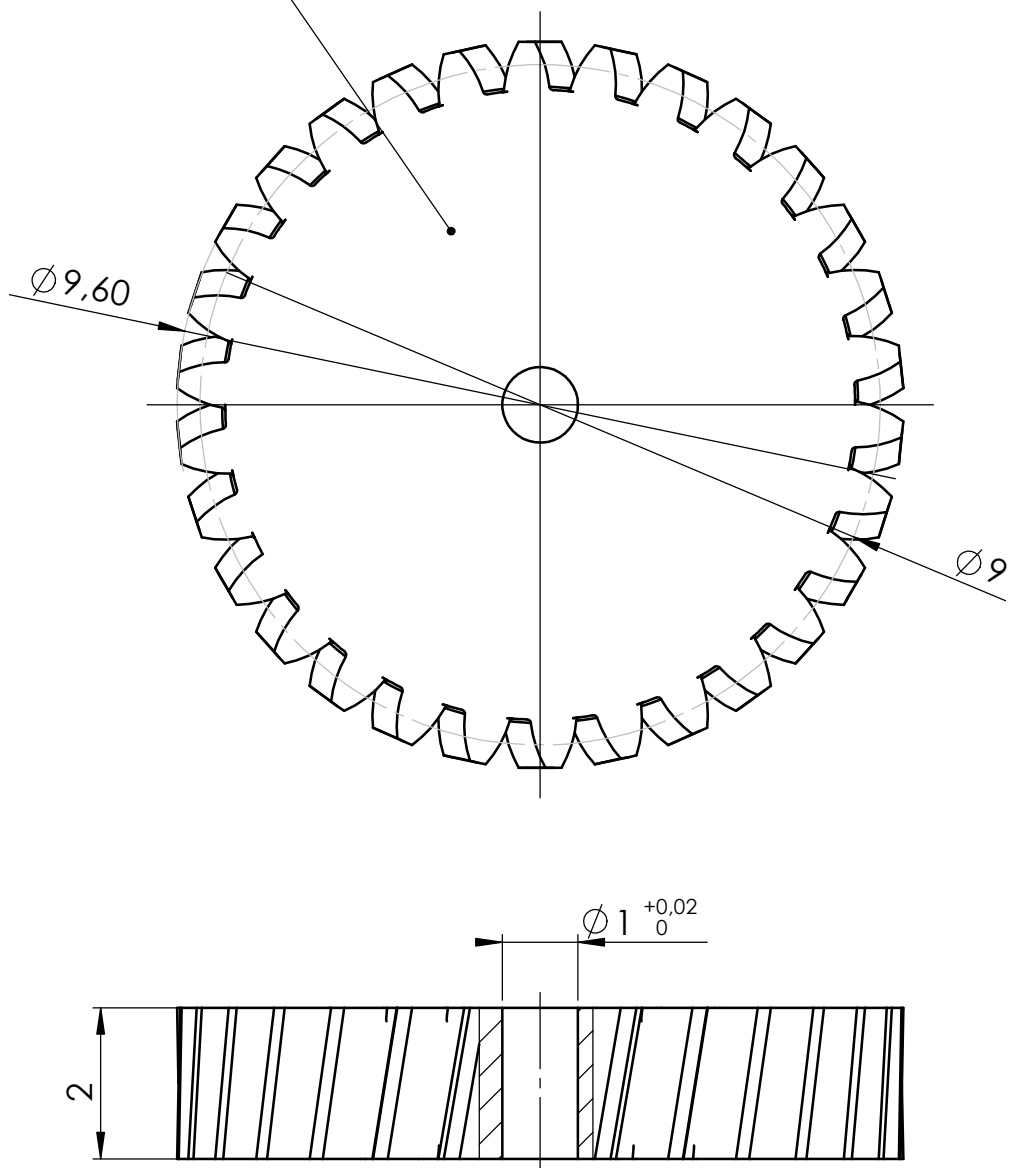

Schneckenrad/ skew gear
 $z=30 / m=0,3$



	Erstellt durch / author SolExpert group	Material / material Messing / brass	Maßstab / scale 10:1	
	Datum / date 02.01.2019	Benennung / description Schneckenrad / skew gear		
		Bestellnummer / order-no Z302S	Blatt 1/1	Rev.