

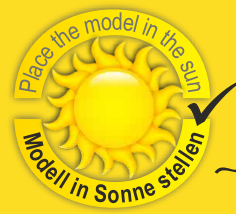

(DT) Kein Spielzeug, Sammlermodell
 (EN) Not a toy, collector's model
 (FR) Pas un jouet, modèle de collection
 (NL) Geen speelgoed, verzamelaars model

Bitte führen Sie die Bauteile nach Ablauf der Gebrauchszeit entsprechend zertifizierten Versorgern zu!



- 1 x **1**
- 2 x **2**
- 1 x **3**
- 1 x **4**
- 1 x **10**
- 2 x **5**
- 1 x **6**
- 1 x **7**
- 1 x **8**
- 2 x **9**
- 1 x **11**
- 1 x **12**



MADE IN EUROPE

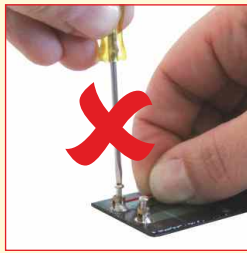
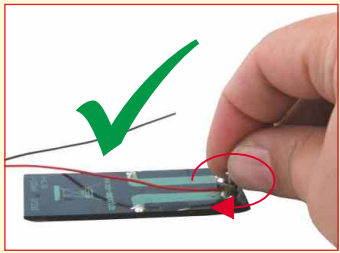

(DT) Die Schrauben dürfen nur leicht mit den Fingern angezogen werden!
Keinen Schraubendreher benutzen! (GB) The screws should be tightened slightly with your fingers! **Do not use screwdriver!** (FR) Les vis doivent être serrées légèrement avec vos doigts! **Ne pas utiliser de tournevis!** (NL) De schroeven moeten enigszins worden aangescherpt met uw vingers! **Gebruik geen schroevendraaier!**

A

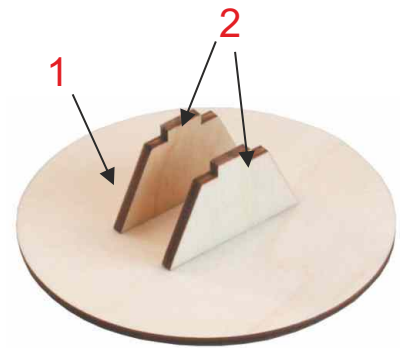

B

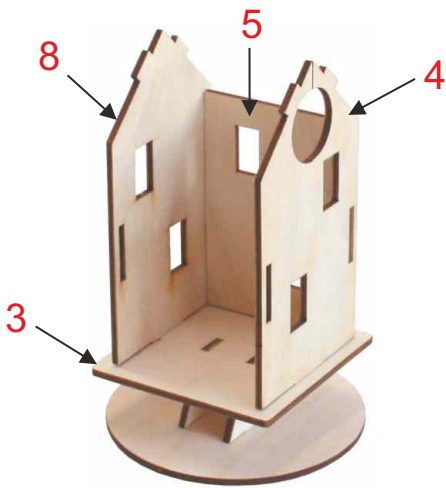

C

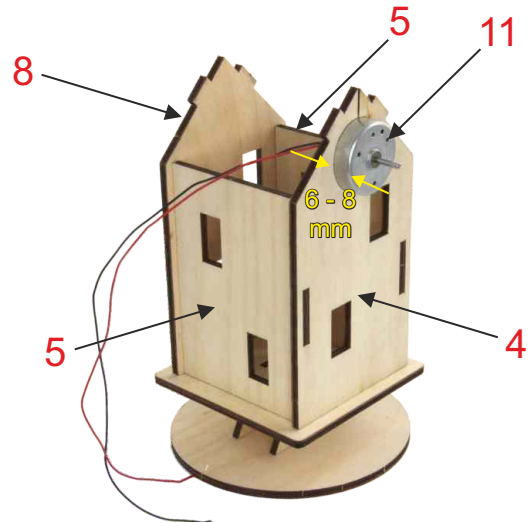

D

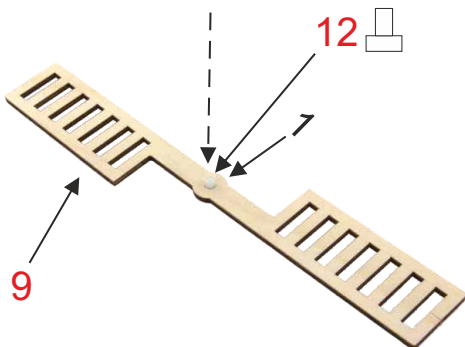

E

