

MAJESTIC[®]

● Model:LED222GS

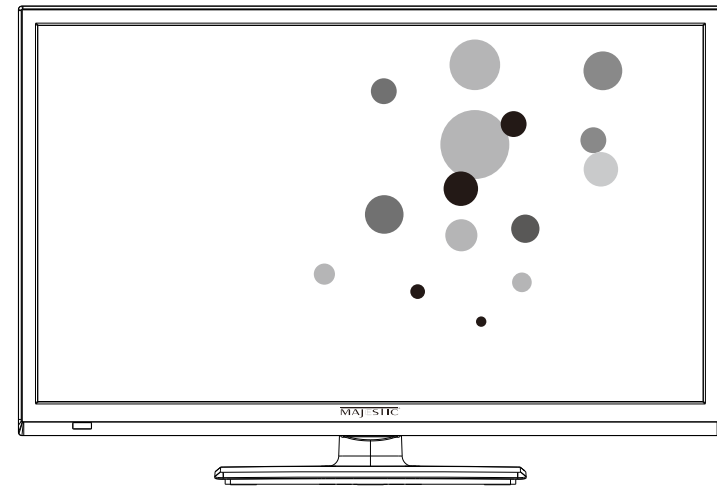

**LED TV
INSTRUCTION MANUAL**

USER'S MANUAL

Safety Information

IMPORTANT SAFETY INSTRUCTIONS

Read these instructions.
Keep these instructions.
Heed all warnings.
Follow all instructions.
Do not use this apparatus near water.
Clean only with dry cloth.
Do not block any ventilation openings. Install in accordance with the manufacturer's instructions.
Do not install near any heat sources such as radiators, heat registers, stoves, or other apparatus (including amplifiers) that produce heat.
Do not defeat the safety purpose of the polarized or grounding plug. A polarized plug has two blades with one wider than the other. A grounding plug has two blades and a third grounding prong. The wide blade or the third prong is provided for your safety. If the provided plug does not fit into your outlet, consult an electrician for replacement of the obsolete outlet.
Protect the power cord from being walked on or pinched particularly at the plugs, convenience receptacles, and at the point where they exit from the apparatus.
Only use attachments/accessories specified by the manufacturer.
Use only with the cart, stand, tripod, bracket, or table specified by the manufacturer, or sold with the apparatus. When a cart or rack is used, use caution when moving the cart/apparatus combination to avoid injury from tip-over.



Unplug the apparatus during lightning storms or when unused for long periods of time.

Refer all servicing to qualified personnel. Servicing is required when the apparatus has been damaged in any way, such as power supply cord or plug is damaged, liquid has been spilled or objects have fallen into the apparatus has been exposed to rain or moisture, does not operate normally, or has been dropped.

CAUTION: These servicing instructions are for use by qualified service personnel only. To reduce the risk of electric shock, do not perform any servicing other than that contained in the operating instructions unless you are qualified to do so.

WARNING : To reduce the risk of fire or electric shock, do not expose this apparatus to rain or moisture. The apparatus shall not be exposed to dripping or splashing and that objects filled with liquids, such as vases, shall not be placed on apparatus.

WARNING: The mains plug is used as disconnect device, the disconnect device shall remain readily operable.



- This lightning flash with arrowhead symbol within an equilateral triangle is intended to alert the user to the presence of non-insulated "dangerous voltage" within the product's enclosure that may be of sufficient magnitude to constitute a risk of electric shock.

- Warning: To reduce the risk of electric shock, do not remove cover (or back) as there are no user-serviceable parts inside. Refer servicing to qualified personnel.

- The exclamation point within an equilateral triangle is intended to alert the user to the presence of important operating and maintenance instructions in the literature accompanying the appliance.

Apparatus with class I construction shall be connected to a mains socket outlet with a protective earthing connection.

Important Safety Precautions

Safety

Please, immediately pull out the AC power plug from adapter if there is an abnormal sound or smell or the LED TV has sound but no picture, and contact after sales support.



The LED TV should be kept free from rain, moisture and dust to prevent electrical shock and short circuits. Do not cover the ventilation openings with table clothes, curtains, newspapers, etc.

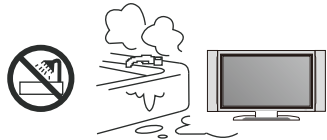

The LED TV should be kept from high temperature heating sources or direct sunlight. Good ventilation is required. Allow 10 cm. between the LED TV and other appliances or built-in cabinet walls.

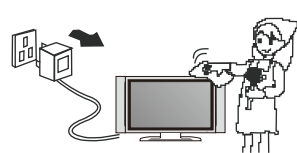
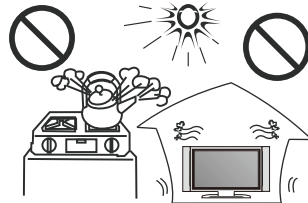

When you wipe the front cabinet, please make sure the power plug is pulled out and use a soft, dry, lint-free cloth and handle it with care. Do not repeatedly wipe the panel, nor scrape, tap or strike the panel with a hard object.

Do not wipe the LED TV with any petrol, chemical or alcohol based solvents as it will lead to product damage of the panel and cabinet.

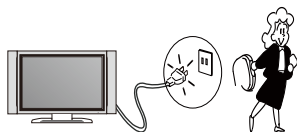
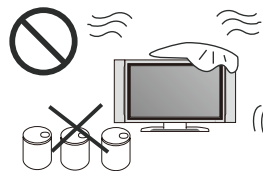

When the television receiver is not used for an extended period of time, it is advisable to disconnect the AC power cord from the AC outlet.

Important Safety Precautions

Safety

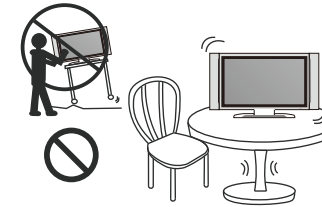

Do not place the LED TV on an unstable surface.

Do not place the power cord or other cables across a walkway in case it is trampled on. Do not overload the power cord or power socket. When the power plug is used to disconnect and connect the device, it should easily go into the power source.

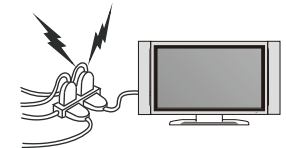

Do not disassemble the back cover, as it contains high voltages inside and will cause electric shock. Only qualified professionals should conduct internal adjustments, maintenance, and checks.

The TV set should not be subjected to water droplets, vapor, or splash. This equipment should not be placed on objects filled with liquids. Do not place flame sources, such as lit candles, on or near the LED TV. Please, pull out the power plug and contact after sales support if there are abnormal objects or water in the TV.

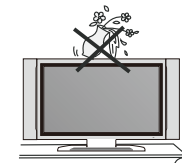

Pull out the power cord and antenna cable during electrical storms so the LED TV is not damaged by electrical surges. Keep all people away from the antenna cable during electrical storms.

I . Content

Safety Information	1
Important Safety Precautions	3
I . CONTENT	4~7
II . Important safety Instruction	8~9
III . Systems Connection incl MMMI	10~13
IV . Remote-Control unit	14~16
V . Main Menu User Guide	
Source	17
1. Picture menu	17
1.1 Picture menu	18
1.2 Function description	18
1.2.1 Picture Mode	18
1.2.2 Brightness	19
1.2.3 Contrast	19
1.2.4 Sharpness	19
1.2.5 Colour	20
1.2.6 TINT	20
1.2.7 Colour Temperature	21
1.2.8 Aspect Ratio	22
1.2.9 Noise Reduction	22
2. Sound menu	23
2.1 Sound Menu	23
2.2 Function description	24
2.2.1 Sound Mode	24
2.2.2 Bass&Treble	25
2.2.3 Balance	26
2.2.4 Surround	26
2.2.5 AVL	27
2.2.6 SPDIF	28
2.2.7 Audio Description	28
3. TV channel	30
3.1 Channel user interface	30
3.2 Function description	31
3.2.1 Channel Manager	31
3.2.1.1 Delete/Skip/Lock	31
3.2.1.2 Swap Channel	31

3.2.2 Favorite Management	32
3.2.3 Country	32
3.2.4 Auto Search	33
3.2.5 Digital Manual Search	36
3.2.6 Analog Manual Search	36
3.2.7 Satellite System	37
4. Feature menu	43
4.1 Feature menu	43
4.2 Function description	43
4.2.1 Lock	43
4.2.2 Language	45
4.2.3 Clock	45
4.2.4 Sleep Timer	46
4.2.5 Auto Power Off	46
4.2.6 Hearing impaired	47
4.2.7 CI Info	47
4.2.8 PVR/Timeshift	47
5. Setup menu	48
5.1 Setup menu	48
5.2 Function description	49
5.2.1 OSD Timer	49
5.2.2 Auto SCART	49
5.2.3 PC Setup	49
5.2.4 Blue Screen	50
5.2.5 Home Mode	50
5.2.6 Reset to Setting	50
5.2.7 Software Upgrade	51
VI . MULTIMEDIA	
1. photo	52
1.1 Format supported	52
1.2 Function introduction	52
1.2.1 Playback	52
1.2.2 Thumbnails	53
2. MUSIC	53
2.1 Format Supported	53
2.2 Function introduction	54
2.2.1 Playback	54
3. Movie	55
3.1 Format supported	55
3.2 Function introduction	55
3.2.1 Playback	56

4. eBook	56
4.1 Format supported	56
4.2 Function introduction	56
4.2.1 Playback	57
VII. Other UI setup	
1. EPG	58
1.1 EPG abstract	58
1.2 Daily mode	58
1.3 Weekly mode:	59
1.4 Extended mode:	60
2. CI setup	60
2.1 Getting access to scrambled channel	60
2.2 Getting ci information	61
2.3 Details of ci information	61
2.3.1 Main Menu	61
2.3.2 Smart Card Management	62
2.3.3 Subscription Information	62
2.3.4 Morality level Setting	62
2.3.5 Change PIN Code	62
2.3.6 System Information	63
2.3.7 Language Setting	63
2.3.8 Others	63
3. PVR For Euro DVB-T2/C/S2 Only	64
3.1 Pvr involved menus	64
3.1.1 PVR/Timeshift menu	64
3.1.2 Partition List menu	65
3.1.3 Timer menu	66
3.1.4 Timer Edit menu	67
3.1.5 Record List menu	68
3.1.6 REC info menu	68
3.1.7 Timeshift info menu	69
3.2 REC	70
3.2.1 REC	70
3.2.2 Timer REC	71
3.2.3 Timeshift	72
3.3 RCE playback	73
3.4 Restriction	73
3.4.1 Device & File System	73
3.4.2 Power Lost or Device Disconnect	74
4. Auto installation	74
5. Channel list menu	76
6. Fav list menu	76

7. USA TV OSD Operating manual	77
VIII. Built-in DVD Player Operation	81
X. Troubleshooting	87
IX. Specifications	89

II. Important safety Instruction

1. TV Controls

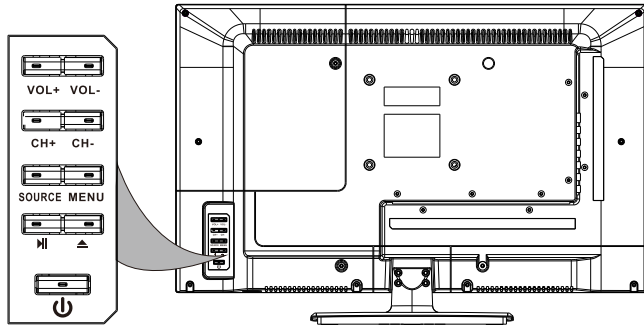

Controls on the TV

1. **MUTE** After you load a disc, press **MUTE** to play the disc, and press **MUTE** twice to pause.
2. **▲** Press the **▲** button when the power is on the disc will eject, Press the **▲** button again to load the disc automatically.
3. **VOL(+)** - This button increases the TV's volume. If the OSD menu is active, pressing this button will move the selection to the right, this button can not active under USA TV and can active by remote controller.
4. **VOL(-)** - This button decreases the TV's volume. If the On Screen Display(OSD) menu is active, pressing this button will move the selection to the left, this button can not active under USA TV and can active by remote controller.
5. **CH(+)** - This button performs the channel up function. If the OSD menu is active, this button functions as up control for the menu, this button can not active under USA TV and can active by remote controller.
6. **CH(-)** - This button performs the channel down function. If the OSD menu is active, this button functions as down control for the menu, this button can not active under USA TV and can active by remote controller.
7. **MENU** - This button activates the OSD menu. If a sub-menu is active, pressing this button will return the selection to the previous menu level.
8. **SOURCE** - This button switches between all the different sources of the TV. When the OSD is active, this button acts as the enter button and confirms the menu selection.
9. **POWER** - Turn on the TV by pressing the button once. Press the button again to turn off the TV.

2. Installation

Wall-mounting

This television set is equipped with VESA mounting points on the back panel for use with wall-mounting brackets (not included).

NOTE:The distance between the holes is 200 x 100 mm in width and height.

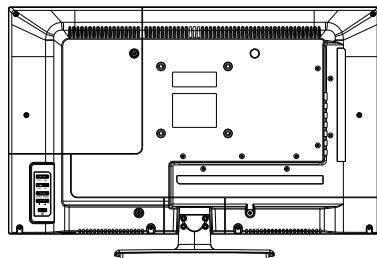

For wall-mounting, remove the screws to remove the entire stand assembly.

3. TV Inputs & Outputs

Rear Bottom

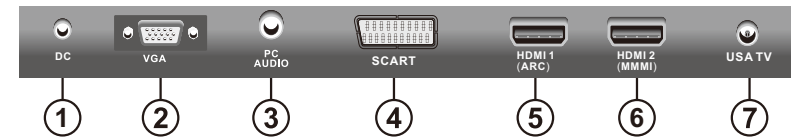

Rear Side

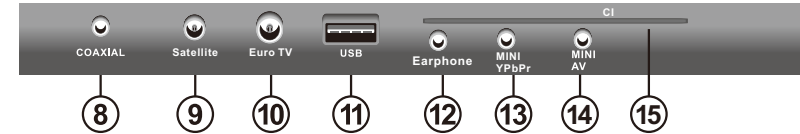

1. DC: DC input
2. VGA: Connect to a computer VGA output jack
3. PC AUDIO: Connect to the audio output jack on a computer
4. SCART: Connecting for SCART signal
5. HDMI1 (ARC): HDMI in
6. HDMI2 (MMMI) : HDMI In
7. USA TV: Connect to an Antenna or Cable (ATSC/NTSC)
8. COAXIAL: Co-axial Digital audio output
9. Satellite: Connect to external Satellite Receiver (Europe & Pacific Region Only)
10. Euro TV: Connect to external Antenna for Analog or Digital TV in ATV/DTV Mode – (DVB-T2, CATV)
11. USB: USB input
12. Earphone: Connecting for headphone
13. MINI YPbPr: Connecting for the Y/Pb/Pr Input in Component mode
14. MINI AV: Connecting for VIDEO signal input in Composite mode.
15. CI: Used to insert the CI card

III. Systems Connection

NOTE: Please make sure the outputs have firm connections before connecting power.

1. PC (VGA and PC Audio Cable not included)

PC: Use the SOURCE button to select PC.

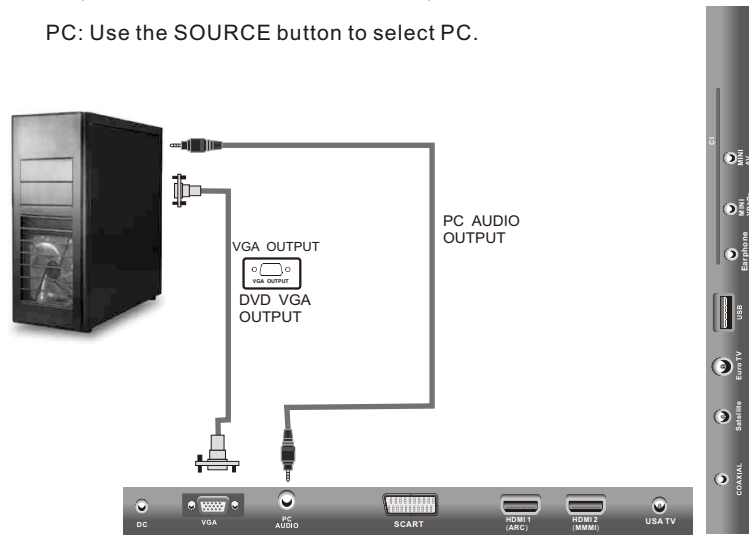

2. MINI AV

Audio/video input: Use the SOURCE button to select AV on the remote control.

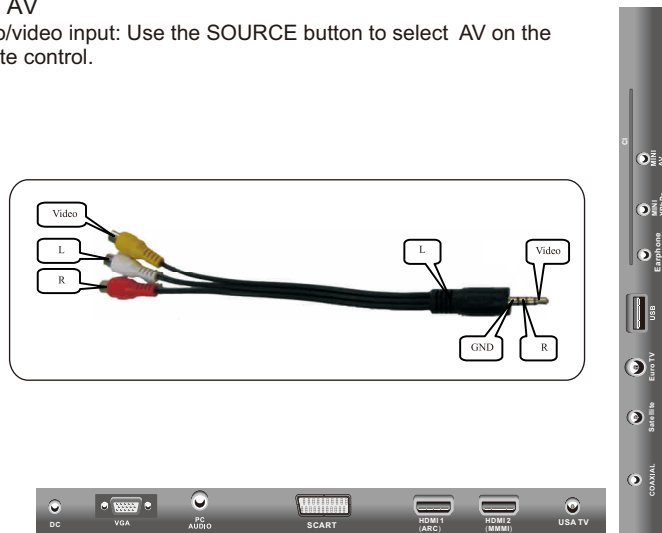

3. HDMI (HDMI Cable Not included)

HDMI input: Use the SOURCE button on the remote control to select HDMI

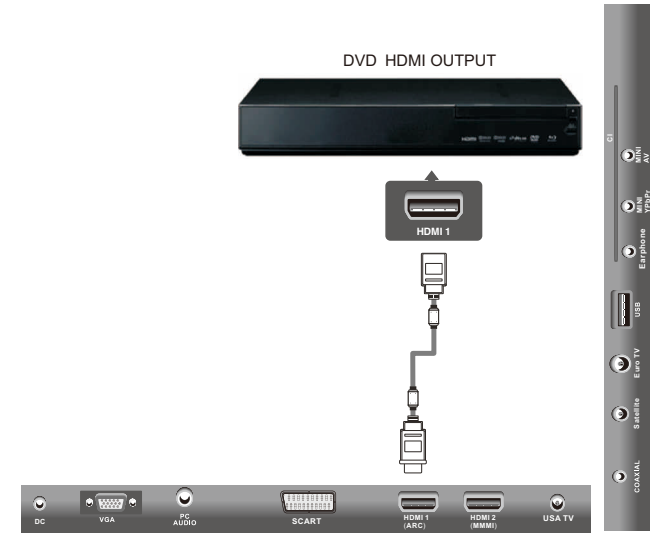

4. MINI YPbPr INPUT

Video component input: Use the SOURCE button on the remote control to select YPbPr.

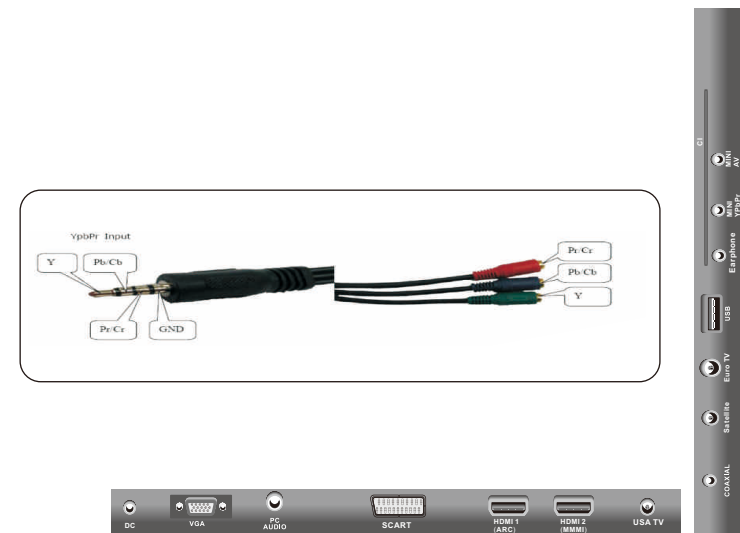

5. SCART INPUT (SCART Cable Not Included)

Use the **SOURCE** button on the remote controller to select SCART.

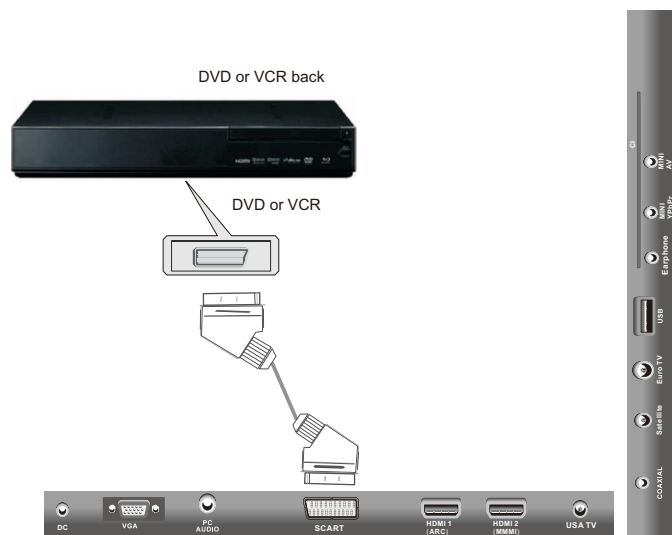

6. USB INPUT (USB Memory Stick not Included)

Use the **SOURCE** button on the remote controller to select Media.



7. COAXIAL OUTPUT

Allows connection of Digital audio systems and Surround Sound.

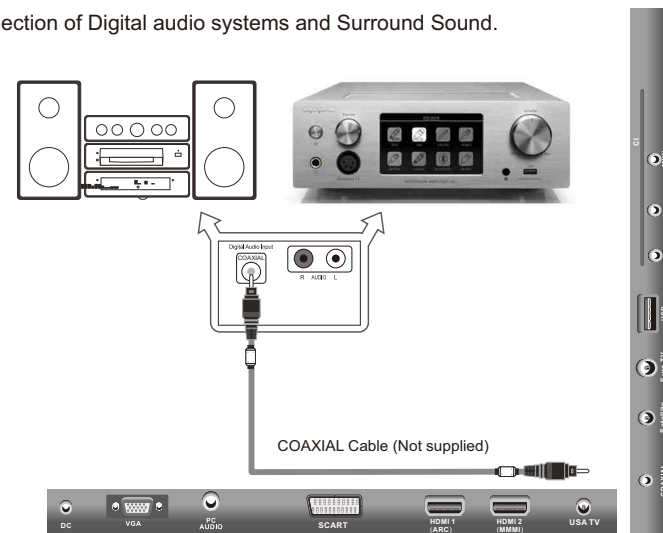

8. MMMI (HDMI Cable and Adaptor to Phone and Tablet Not Included)

Allows you to connect your Android or iOS phone or Tablet to display the mobile device on the TV Screen.

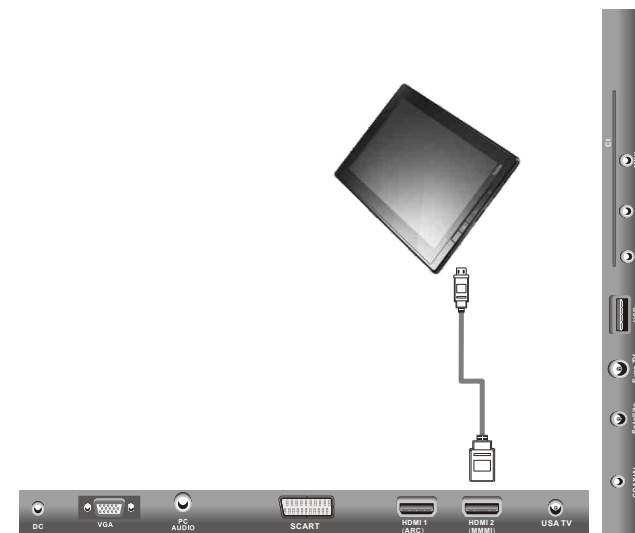

IV. Remote-Control unit

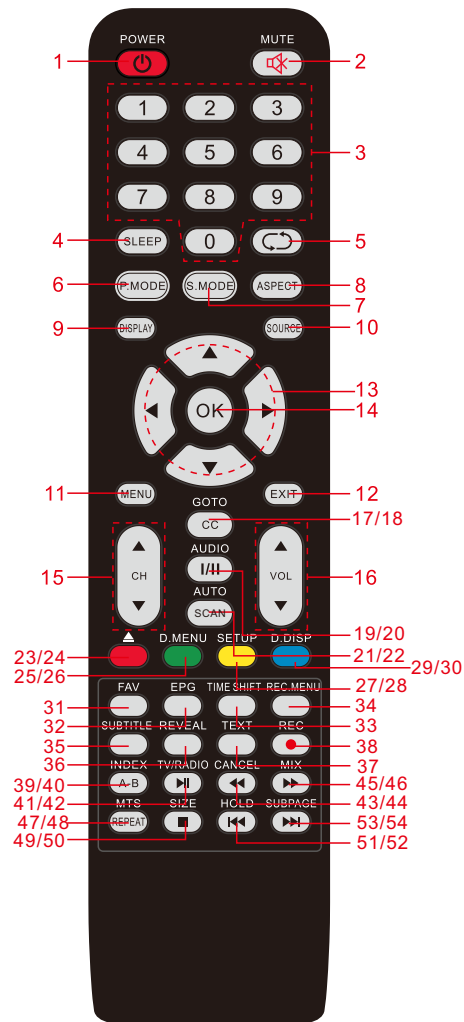

No.	Button	Description
1	POWER	Turns the TV on or off to standby mode.
2	MUTE	Press to mute the sound. Press again to regain sound.
3	0-9	Press 0-9 to select a TV channel directly. The channel will change after 2 seconds.
4	SLEEP	Set the delay time for the TV to turn off automatically.
5	↻	Return to the previously viewed program.
6	P.MODE	Select the picture mode.
7	S.MODE	Select the sound mode.
8	ASPECT	Press this button to select the aspect ratio of the screen.
9	DISPLAY	Press to display the source and channel info.
10	SOURCE	Press to select signal the source for the TV.
11	MENU	Allows you to navigate the on screen menus (OSD).
12	EXIT	Exit from the current menu or sub-menu.
13	◀▶ ▲▼	Allows you to navigate the on-screen menus and adjust the system settings to your preference.
14	OK	Select the option.
15	CH+/-	Press these two buttons to change channels up/down.
16	VOL+/-	Press these two buttons to increase/decrease the volume.
17	GOTO	Press this button to go to desired position
18	CC	Press to turn ON/OFF captions
19	AUDIO	Press to change the DTV or DVD audio language.
20	I/II	Select NICAM audio mode. Only be available for TV programmers with NICAM transmission,
21	SCAN	Quick Tune. Quick TV Channel Autotune Button.
22	AUTO	Use for adjustments in PC mode.
23	▲	Eject/insert disc.
24	R(DELETE)	Delete function button.
25	D.MENU	Quick Teletext navigation or setup settings / DVD: Video DVD Menu button.
26	G(RENAME)	Rename function button.
27	SETUP	DVD system setup.
28	Y(MOVE)	Move function button.
29	D.SISP	Quick navigation during Teletext or setup settings / DVD: DVD Information button.
30	B(SKIP)	Skip function button.
31	FAV	Selects favorite channel(s).
32	EPG	Press to display EPG (Electronic Program Guide).
33	TIME SHIFT	Press to switch to TIME SHIFT mode.
34	REC.MENU	Press to switch to REC.MENU immediately (DTV only).
35	SUBTITLE	Press to select the subtitle language.
36	REVEAL	Shows hidden words or pages by Teletext.
37	TEXT	Switch on/off of Teletext window.

N	Button	Description
38	REC/●	Press to record the program immediately.
39	INDEX	Returns to Index page by Teletext.
40	A-B	You can repeatedly play a given portion by operating as follows: To press this button once to define the portionhead. To press this button again to define the portion toe. Then the portion will be played repeatedly. To press this button again to return to normal playback.
41	⏸	Play and Pause Media-Player / DVD.
42	TV/RADIO	Press to switch between DTV and radio programs
43	⏮	Fast Rewind Media-Player and DVD.
44	CANCEL	Switches the Teletext window to the background; only the current page no is visible.
45	⏭	Fast Forward Media-Player and DVD.
46	MIX	Sets the transparency of Teletext window.
47	REPEAT	DVD: Repeat mode selection.
48	MTS	When stereo program is received, press this button to switch sound system between mono and stereo. When SAP program is received, press this button to switch sound system between mono and SAP. When stereo and SAP program is received, press this button to switch among mono, stereo and SAP.
49	■	Stops playback Media-Player and DVD.
50	SIZE	Zoom In or Out of the Teletext window.
51	⏮	Plays the previous Media Player or DVD file/chapter.
52	HOLD	Holds on the current Teletext page.
53	⏭	Plays the next Media Player or DVD file/chapter..
54	SUBPAGE	Displays a sup-page of upper Teletext options.

Teletext function

Teletext or Austext is no longer available in Australia, nor is there any plan for a replacement. For more information, please visit the websites of the Australian channel providers.

However, one teletext option, "closed captions", is still available on most Australian television channels. This service allows you to activate subtitles while watching normal television programs that provide it.

Accessing closed captions

While watching a program, press the teletext button (TEXT/MIX) on the remote control, then enter the numbers 801 on the remote control to activate the subtitles. To exit the subtitles, press the TEXT/MIX button again.

V. Main Menu User Guide

SOURCE

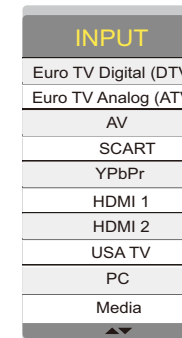

Press SOURCE button to display the input source list.
Press ▼/▲ button to select the input source you want to watch.
Press ENTER button to enter the input source.

1. Picture Menu

This chapter will describe the function of Picture in mainmenu.

1.1 Picture Menu

It will open the mainmenu by pressing down the button "MENU" on the remote. The focus will move to the sub items in the Picture menu by pressing down the button "RIGHT" and then functions in the Picture can be set. The Picture menu is shown as follows:



The range and the default values of every sub items in Picture menu are shown in the following table:

Section	Picture Menu Items	Value	Default
1.2.1	Picture Mode	Standard, Mild, Dynamic, User	Standard
1.2.2	Brightness	0~100	50
1.2.3	Contrast	0~100	50
1.2.4	Sharpness	0~100	50
1.2.5	Colour	0~100	50
1.2.6	Tint	0~100	50
1.2.7	Color Temp	Standard, Warm, Cool	Standard
1.2.8	Aspect Ratio	Full;Auto 4:3 16:9 Zoom1 Zoom2 Panorama Just Scan	Full
1.2.9	Noise Reduction	Off,Low,Middle,High	Middle

The result of the action pressing down some button when in Picture menu:

Key Stroke	Action
KEY_UP	Highlight the previous sub item. If it is the first button currently, then highlight the last one in the list.
KEY_DOWN	Highlight the next sub item. If it is the last button in the list currently, then highlight the first one.
KEY_LEFT	Back to Main Menu.
KEY_RIGHT	If the current focus sub item is "Picture Mode"、"Color Temperature"、"Aspect Ratio" or "Noise Reduction", a popup menu will appear for user to make further choice. If not, mainmenu will be cleaned for new "adjust menu".
KEY_OK	Same as KEY_RIGHT。
KEY_MENU	Back to Main Menu.
KEY_EXIT	Exit Main Menu.

1.2 Function Description

1.2.1 Picture Mode



Selecting Picture Mode – Standard, Mild, Dynamic or User is the same as the function when pressing button KEY_PICTURE_MOD on the remote.

Key Operation

Key	Action
KEY_UP	Highlight the previous sub item. If it is the first button currently, then highlight the last one in the list. Adjust the current value and save it momentarily.
KEY_DOWN	Highlight the next sub item. If it is the last button in the list currently, then highlight the first one. Adjust the current value and save it momentarily.
KEY_LEFT	The current focused value will be selected and popup menu will be cleaned, then back to Picture menu.
KEY_RIGHT	The current focused value will be selected and popup menu will be cleaned, then back to Picture menu.
KEY_OK	The current focused value will be selected and popup menu will be cleaned, then back to Picture menu.
KEY_MENU	The current focused value will be selected and popup menu will be cleaned, then back to Picture menu.
KEY_EXIT	Exit Main Menu.

1.2.2 Brightness

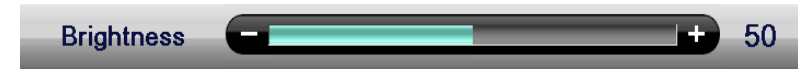

- 1) The overall brightness level of the picture. the higher, the brighter.
- 2) Key Operation

Key Stroke	Action
KEY_UP	Enter backlight adjusting
KEY_DOWN	Enter contrast adjusting
KEY_LEFT	Decrease the value of brightness, minimum value is 0
KEY_RIGHT	Increase the value of brightness, maximum value is 100
KEY_OK	Close adjust menu and back to Picture Menu
KEY_MENU	Close adjust menu and back to Picture Menu
KEY_EXIT	Exit Main Menu.

1.2.3 Contrast

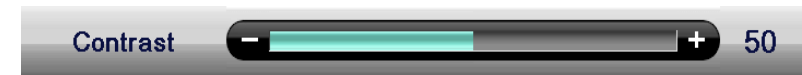

- 1) The difference in color and light between parts of an image. The higher, the difference that the user feel stronger.
- 2) Key Operation

Key Stroke	Action
KEY_UP	Enter brightness adjusting
KEY_DOWN	Enter sharpness adjusting
KEY_LEFT	Decrease the value of contrast, minimum value is 0
KEY_RIGHT	Increase the value of contrast, maximum value is 100
KEY_OK	Close adjust menu and back to Picture Menu
KEY_MENU	Close adjust menu and back to Picture Menu
KEY_EXIT	Exit Main Menu.

1.2.4 Sharpness

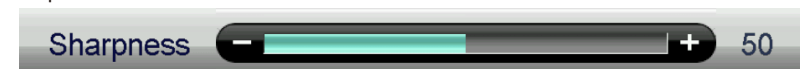

- 1) The sharpness of picture. The higher, the more distinct user feels and there is to be more sawtooth and burr.
- 2) Key Operation

Key Stroke	Action
KEY_UP	Enter contrast adjusting
KEY_DOWN	Enter colour adjusting
KEY_LEFT	Decrease the value of sharpness, minimum value is 0
KEY_RIGHT	Increase the value of sharpness, maximum value is 100
KEY_OK	Close adjust menu and back to Picture Menu
KEY_MENU	Close adjust menu and back to Picture Menu
KEY_EXIT	Exit Main Menu.

1.2.5 Colour

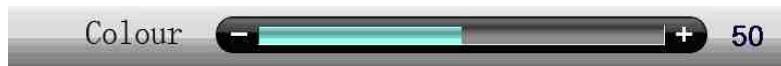

- 1)The vividness of color. The higher, the stronger.
- 2)Key Operation

Key Stroke	Action
KEY_UP	Enter sharpness adjusting
KEY_DOWN	Enter tint adjusting only when Picture Mode is User and current source pattern is NTSC. Otherwise enter brightness adjusting.
KEY_LEFT	Decrease the value of saturation, minimum value is 0
KEY_RIGHT	Increase the value of saturation, maximum value is 100
KEY_OK	Close adjust menu and back to Picture Menu
KEY_MENU	Close adjust menu and back to Picture Menu
KEY_EXIT	Exit Main Menu.

1.2.6 TINT

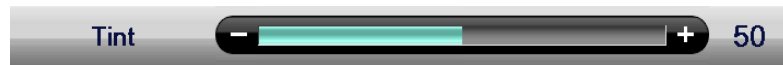

- 1)TINT adjusting. It is not available unless Picture Mode is set to be user and the current TV system is NTSC.

1)Key Operation

Key Stroke	Action
KEY_UP	Enter colour adjusting
KEY_DOWN	Enter backlight adjusting
KEY_LEFT	Decrease the value of tint, minimum value is 0
KEY_RIGHT	Increase the value of tint, maximum value is 100
KEY_OK	Close adjust menu and back to Picture Menu
KEY_MENU	Close adjust menu and back to Picture Menu
KEY_EXIT	Exit Main Menu.

1.2.7 Colour Temperature



- 1) Color temperature adjusting. There are three choices:standard, warm, cool.
- 2) Key Operation

Key Stroke	Action
KEY_UP	Highlight the previous sub item. If it is the first button currently, then highlight the last one in the list. Adjust the current value and save it momentarily.
KEY_DOWN	Highlight the next sub item. If it is the last button in the list currently, then highlight the first one. Adjust the current value and save it momentarily.
KEY_LEFT	The current focused value will be selected and popup menu will be cleaned, then back to Picture menu.
KEY_RIGHT	The current focused value will be selected and popup menu will be cleaned, then back to Picture menu.
KEY_OK	The current focused value will be selected and popup menu will be cleaned, then back to Picture menu.
KEY_MENU	The current focused value will be selected and popup menu will be cleaned, then back to Picture menu.
KEY_EXIT	Exit Main Menu.

1.2.8 Aspect Ratio



1) Aspect Ratio – Auto, 4:3, 16:9, Zoom1, Zoom2 or Panorama is the same as the function when pressing button KEY_ASPECT on the remote.

2) Key Operation

Key	Action
KEY_UP	Highlight the previous sub item. If it is the first button currently, then highlight the last one in the list. Adjust the current value and save it momentarily.
KEY_DOWN	Highlight the next sub item. If it is the last button in the list currently, then highlight the first one. Adjust the current value and save it momentarily.
KEY_LEFT	The current focused value will be selected and popup menu will be cleaned, then back to Picture menu.
KEY_RIGHT	The current focused value will be selected and popup menu will be cleaned, then back to Picture menu.
KEY_OK	The current focused value will be selected and popup menu will be cleaned, then back to Picture menu.
KEY_MENU	The current focused value will be selected and popup menu will be cleaned, then back to Picture menu.
KEY_EXIT	Exit Main Menu.

1.2.9 Noise Reduction

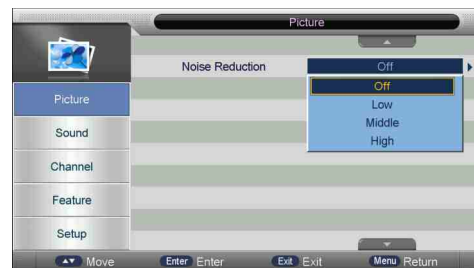

1) Noise reduction of the picture. To reduce noise and improve the appearance of the picture. No noise reduction operation if it's "off". From Low->Middle->High, noise reduction effects better but it will cause a blur on picture.

2) Key Operation

Key Stroke	Action
KEY_UP	Highlight the previous sub item. If it is the first button currently, then highlight the last one in the list. Adjust the current value and save it momentarily.
KEY_DOWN	Highlight the next sub item. If it is the last button in the list currently, then highlight the first one. Adjust the current value and save it momentarily.
KEY_LEFT	The current focused value will be selected and popup menu will be cleaned, then back to Picture menu.
KEY_RIGHT	The current focused value will be selected and popup menu will be cleaned, then back to Picture menu.
KEY_OK	The current focused value will be selected and popup menu will be cleaned, then back to Picture menu.
KEY_MENU	The current focused value will be selected and popup menu will be cleaned, then back to Picture menu.
KEY_EXIT	Exit Main Menu.

2. Sound Menu

This chapter will describe the function of Sound in mainmenu.

2.1 Sound Menu

It will open the mainmenu by pressing down the button "MENU" and then press the button "down" on the remote. The focus will move to the sub items in the Sound menu by pressing down the button "RIGHT" and then functions in the Sound can be set. The Sound menu is shown as follows:



The range and the default values of every sub items in Sound menu are shown in the following table:

Section	Sound Menu Items	Value	Default
2.2.1	Sound Mode	Standard,Movie,Music,Speech,User	Standard
2.2.2	Bass	0~100	50
2.2.3	Treble	0~100	50
2.2.4	Balance	-50~50	0
2.2.5	Surround	Off,On	Off
2.2.6	AVL	Off,On	Off
2.2.7	SPDIF	Off,PCM,Auto	Off
2.2.8	Audio Description	"ENTER"	

The result of the action pressing down some button when in Sound menu:

Key Stroke	Action
KEY_UP	Highlight the previous sub item. If it is the first button currently, then highlight the last one in the list.
KEY_DOWN	Highlight the next sub item. If it is the last button in the list currently, then highlight the first one.
KEY_LEFT	Back to main menu
KEY_RIGHT	If the current focus sub item is " Sound Mode"/" Surround" / " Stable Sound",a popup menu will appear for user to make further choice. If not, main menu will be cleaned for new "adjust menu".
KEY_OK	Same as KEY_RIGHT.
KEY_MENU	Back to main menu
KEY_EXIT	Exit Main Menu.

2.2 Function Description

2.2.1 Sound Mode



Selecting Sound Mode - Standard, Movie, Music, Speech or User is the same as the function when pressing button KEY_SOUND_MOD on the remote. Default values are as follows

Sound Mode	(Bass, Treble)
Standard	(50, 50)
Movie	(80, 60)
Music	(60, 30)
Speech	(40, 60)
User	(50, 50)

Key Operation

Key Stroke	Action
KEY_UP	Highlight the previous sub item. If it is the first button currently, then highlight the last one in the list. Adjust the current value and save it momentarily.
KEY_DOWN	Highlight the next sub item. If it is the last button in the list currently, then highlight the first one. Adjust the current value and save it momentarily.
KEY_LEFT	The current focused value will be selected and popup menu will be cleaned, then back to Sound menu.
KEY_RIGHT	The current focused value will be selected and popup menu will be cleaned, then back to Sound menu.
KEY_OK	The current focused value will be selected and popup menu will be cleaned, then back to Sound menu.
KEY_MENU	The current focused value will be selected and popup menu will be cleaned, then back to Sound menu.
KEY_EXIT	Exit Main Menu.

2.2.2 Bass&Treble

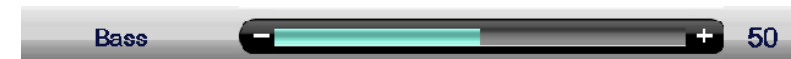

1)Bass: the bass of the output sound; Treble: the treble of the output sound.

2)Key Operation

Key Stroke	Action
KEY_UP	Enter Bass/Treble/Balance adjusting
KEY_DOWN	Enter Bass/Treble/Balance adjusting
KEY_LEFT	Decrease the value of Bass/Treble, minimum value is 0
KEY_RIGHT	Increase the value of Bass/Treble, maximum value is 100
KEY_OK	Close adjust menu and back to Sound Menu
KEY_MENU	Close adjust menu and back to Sound Menu
KEY_EXIT	Exit Main Menu.

Notes when changing Sound Mode, if Mute function is on and the UI looks as follows, the Mute function will be turned off so that the user can feel the difference in different sound mode.



2.2.3 Balance



Balance between the left and right track of the output sound. If balance is negative, the sound in the left track is louder. If balance is positive, the sound in the right track is louder.

Key Operation:

Key Stroke	Action
KEY_UP	Enter Bass/Treble/Balance adjusting
KEY_DOWN	Enter Bass/Treble/Balance adjusting
KEY_LEFT	Decrease the value of Balance, minimum value is -50
KEY_RIGHT	Increase the value of Balance, maximum value is 50
KEY_OK	Close adjust menu and back to Sound Menu
KEY_MENU	Close adjust menu and back to Sound Menu
KEY_EXIT	Exit Main Menu.

2.4.4 Surround



- 1) Switch for Surround function
- 2) Key Operation

Key Stroke	Action
KEY_UP	Highlight the previous sub item. If it is the first button currently, then highlight the last one in the list. Adjust the current value and save it momentarily.
KEY_DOWN	Highlight the next sub item. If it is the last button in the list currently, then highlight the first one. Adjust the current value and save it momentarily.
KEY_LEFT	The current focused value will be selected and popup menu will be cleaned, then back to Sound menu.
KEY_RIGHT	The current focused value will be selected and popup menu will be cleaned, then back to Sound menu.
KEY_OK	The current focused value will be selected and popup menu will be cleaned, then back to Sound menu.
KEY_MENU	The current focused value will be selected and popup menu will be cleaned, then back to Sound menu.
KEY_EXIT	Exit Main Menu.

2.4.5 AVL



- 1) Switch for AVL function
- 2) Key Operation

Key Stroke	Action
KEY_UP	Highlight the previous sub item. If it is the first button currently, then highlight the last one in the list. Adjust the current value and save it momentarily.
KEY_DOWN	Highlight the next sub item. If it is the last button in the list currently, then highlight the first one. Adjust the current value and save it momentarily.
KEY_LEFT	The current focused value will be selected and popup menu will be cleaned, then back to Sound menu.
KEY_RIGHT	The current focused value will be selected and popup menu will be cleaned, then back to Sound menu.
KEY_OK	The current focused value will be selected and popup menu will be cleaned, then back to Sound menu.
KEY_MENU	The current focused value will be selected and popup menu will be cleaned, then back to Sound menu.
KEY_EXIT	Exit Main Menu.

2.4.6 SPDIF



- 1) Switch for SPDIF function
- 2) Key Operation

Key Stroke	Action
KEY_UP	Highlight the previous sub item. If it is the first button currently, then highlight the last one in the list. Adjust the current value and save it momentarily.
KEY_DOWN	Highlight the next sub item. If it is the last button in the list currently, then highlight the first one. Adjust the current value and save it momentarily.
KEY_LEFT	The current focused value will be selected and popup menu will be cleaned, then back to Sound menu.
KEY_RIGHT	The current focused value will be selected and popup menu will be cleaned, then back to Sound menu.
KEY_OK	The current focused value will be selected and popup menu will be cleaned, then back to Sound menu.
KEY_MENU	The current focused value will be selected and popup menu will be cleaned, then back to Sound menu.
KEY_EXIT	Exit Main Menu.

2.4.7 Audio Description

This is to facilitate for the disabilities whose eyes are not good.



- 1) Switch for Audio Description function
- 2) Key Operation

Key Stroke	Action
KEY_UP	No Function
KEY_DOWN	No Function
KEY_LEFT	The current focused value will be selected and popup menu will be cleaned, then back to Sound menu.
KEY_RIGHT	It will enter sub menu to swith the mode of Audio Description.
KEY_OK	It will enter sub menu to swith the mode of Audio Description.
KEY_MENU	The current focused value will be selected and popup menu will be cleaned, then back to Sound menu.
KEY_EXIT	Exit Main Menu.



- 1) Switch for Audio Description function
- 2) Key Operation

Key Stroke	Action
KEY_UP	Highlight the previous sub item. If it is the first button currently, then highlight the last one in the list. Adjust the current value and save it momentarily.
KEY_DOWN	Highlight the next sub item. If it is the last button in the list currently, then highlight the first one. Adjust the current value and save it momentarily.
KEY_LEFT	The current focused value will be selected and popup menu will be cleaned, then back to Audio Description menu.
KEY_RIGHT	The current focused value will be selected and popup menu will be cleaned, then back to Audio Description menu.
KEY_OK	The current focused value will be selected and popup menu will be cleaned, then back to Audio Description menu.
KEY_MENU	The current focused value will be selected and popup menu will be cleaned, then back to Audio Description menu.
KEY_EXIT	Exit Main Menu.



- 1) Switch for Audio Description function
- 2) Key Operation

Key Stroke	Action
KEY_UP	Highlight the previous sub item. If it is the first button currently, then highlight the last one in the list. Adjust the current value and save it momentarily.
KEY_DOWN	Highlight the next sub item. If it is the last button in the list currently, then highlight the first one. Adjust the current value and save it momentarily.
KEY_LEFT	The current focused value will be selected and popup menu will be cleaned, then back to Sound menu.
KEY_RIGHT	In mode,it will enter sub menu to swith the mode of Audio Description.In volume,it will entersub menu to adjust volume.
KEY_OK	In mode,it will enter sub menu to swith the mode of Audio Description.In volume,it will entersub menu to adjust volume.
KEY_MENU	The current focused value will be selected and popup menu will be cleaned, then back to Sound menu.
KEY_EXIT	Exit Main Menu.

3.TV Channel

3.1 Channel User Interface

Press "Menu" "Down(▼)" "Down(▼)" "Right(▶)" to enter channel operation user interface in ATV/DTV/Radio Source as follows:



There are following functions in this page:

- Channel Management: To manage (Delete/Rename/Swap/Lock/Skip) all channels;
- Favorite Management: To manage (Add/Delete) Favorite channels;
- Country: To select country;
- TV connection: To select the DTV signal mode(Air/Cable/Satellite);
- Auto Search: To select auto search mode (All/Digital/Analogue);
- Digital Manual Search: To search digital channel by entering parameters manually(only for Air/Cable);
- Analogue Manual Search: To search analogue channel by entering parameters manually (only for ATV);
- Satellite System: To enter the satellite system setting menu.

3.2 Function Description

3.2.1 Channel Manager

Press "ENTER" or "RIGHT" key on "Channel management" of "Channel" page in ATV or DTV source. The operation interface shows as follow:



3.2.1.1 Delete/Skip/Lock

1) Press "UP (▲)" and "DOWN (▼)" key to select the programs to be deleted and press "RED", "GREEN" or "YELLOW" key to mark them as following:



2) After marking press "MENU" key to save the result.

3.2.1.2 Swap Channel

Select the program to be swapped and press "BLUE" key, the selected program will Blink and them select another program and press "BLUE" key to swap them.

3.2.2 Favorite Management

1) Press “ENTER” or “RIGHT” key on “Favorite management” of “Channel” page in ATV or DTV source. The operation interface shows as follow:

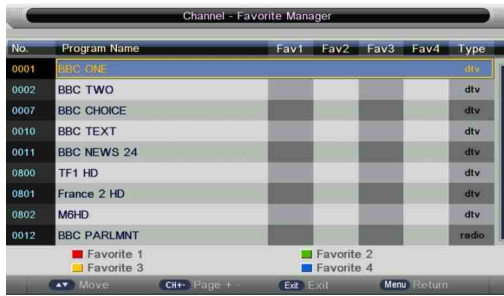

2) Press “UP (▲)” and “DOWN (▼)” key to select the programs to be added into favorite list and press “RED”, “GREEN”, “YELLOW” or “BLUE” key to mark them as following:



3) Press “MENU” key to return “Favorite management” page and save the result.

3.2.3 Country



- 1) Select the country.
- 2) Key Operation

Key Stroke	Action
KEY_UP	Highlight the previous sub item. If it is the first button currently, then highlight the last one in the list. Adjust the current value and save it momentarily.
KEY_DOWN	Highlight the next sub item. If it is the last button in the list currently, then highlight the first one. Adjust the current value and save it momentarily.
KEY_LEFT	The current focused value will be selected and popup menu will be cleaned, then back to Channel menu.
KEY_RIGHT	The current focused value will be selected and popup menu will be cleaned, then back to Channel menu.
KEY_OK	The current focused value will be selected and popup menu will be cleaned, then back to Channel menu.
KEY_MENU	The current focused value will be selected and popup menu will be cleaned, then back to Channel menu.

3.2.4 Auto Search

3.2.4.1 Air signal mode

Select “Auto Search” item to enter auto search user operation interface as following:



All Mode: Select “All” item to scan all digital channels carried by current signal mode firstly and then switch to scan all analog channels in selected country automatically. User can skip digital search to analog search directly by entering “EXIT” or “MENU” key and can also stop auto scan directly by entering “EXIT” or “MENU” during analog scanning.
 Digital Mode: Select “Digital” item to search all digital channels in selected country carried by current signal mode. User can stop search directly by entering “EXIT” or “MENU” key.
 Analog Mode: Select “Analogue” item to search all digital channels in selected country carried by current signal mode. User can stop search directly by entering “EXIT” or “MENU” key.
 All search mode processing interface display as following:



3.2.4.2 Cable signal mode

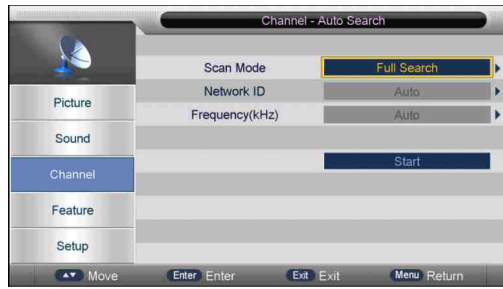

Operations in satellite Auto Search menu are shown in the following table

Option	Value
Scan Mode	Full Search, Network Search

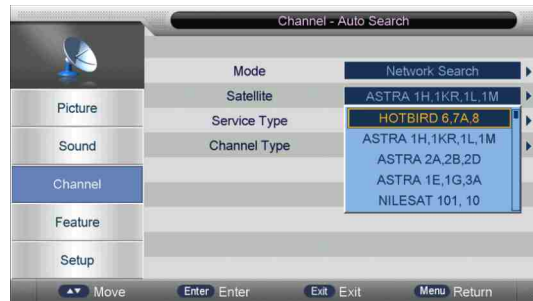

Operations in satellite Auto Search menu are shown in the following table

Option	Value
Mode	Default, Network Search, Full Search
Satellite	65 satellite for searching(3 user edit satellite)
Service Type	All Services, Free Service
Channel Type	All, TV Only

3.2.5 Digital Manual Search

3.2.5.1 Air signal mode

Select "Digital Manual Search" item to enter air channel manual search in DTV source and the user operation interface as following:



Select channel number by "RIGHT" key or entering number directly. The strength and the quality shows at the bottom. Press "ENTER" key on "Start" item to start current channel search. The manual searching UI and the auto searching UI are the same.

3.2.5.2 Cable signal mode



Select channel number by "RIGHT" key or entering number directly. The strength and the quality shows at the bottom. Press "ENTER" key on "Start" item to start current channel search.

3.2.6 Analog Manual Search

Select "Analogue Manual Search" item to enter analogue manual search in ATV source and the user operation interface as following:



These parameters in this page show as the following table:

Analog Parameters	Value	Default
Current Channel	001-100	001
Frequency	Show the Frequency when srech	Frequency of the current channel
Search	Press the button "enter" to open the search sub page.	
Fine Tune	Press the button "enter" to open the fine tune sub page.	
Color System	Auto/PAL/SECAM	Color System of the current channel
Sound System	BG/DK/1/L/L'	Sound System of the current channel

Enter these parameters and then select "Search" item to enter analog channel tune. A dialog popup on left bottom:



Press "Left(◀)" to search channel carried in lower frequency and "Right(▶)" key to search channel carried in higher frequency. Press "MENU" key to return to "Channel-Analogue Manual Search" page and press "RED" key to save the scanned channel to database.

User also can select "Fine Tune" item to fine tune current channel and the UI shows as the last picture. Press "Left(◀)", "Right(▶)" key to fine tune current channel. Press "MENU" key to return to "Channel-Analogue Manual Search" page and press "RED" key to save the tuned channel to database.

3.2.7 Satellite System

Select "Satellite System" item to enter the satellite system setting menu and the user operation interface as following:



3.2.7.1 Satellite List

0002	STRA 1H,1KR,1L,1M
0003	ASTRA 2A,2B,2D
0004	ASTRA 1E,1G,3A
0005	NILESAT 101, 10
0006	EUTELSAT W3A
0007	EUTELSAT W1
0008	BADR-2,3,4EURO
0009	EUTELSAT SESAT

Operations in Satellite List Menu are shown in the following table:

Key Stroke	Action
KEY_UP	use cursor to up
KEY_DOWN	use cursor to down
KEY_LEFT	switch operation to satellite system parameters setting list
KEY_RIGHT	switch operation to Transponder list
KEY_MENU	Back to Main Menu.
KEY_EXIT	Exit Main Menu.
KEY_GREEN	Enter satellite edit menu
KEY_BLUE	Enter satellite scan menu

satellite edit menu



Operations in satellite edit menu are shown in the following table:

Option	Value
Satellite	Enter Satellite Rename edit menu
Longitude Direction	East ,West
Longitude Angle	Press num key to set the Angle
Band	C,Ku band choose

satellite edit menu



Operations in satellite scan menu are shown in the following table

Option	Value
Scan Mode	Default,Network Search,Full Search
Channel Type	All,TV only
Service Type	All Services,Free Service
Polarity	Auto ,Vertical,Horizontal

3.2.7.2 Transponder List



Operations in Transponder List Menu are shown in the following table:

Key Stroke	Action
KEY_UP	use cursor to up
KEY_DOWN	use cursor to down
KEY_LEFT	switch operation to Satellite list
KEY_RIGHT	switch operation to satellite system parameters setting list
KEY_ENTER	Select/unselect cursor item Transponder.
KEY_MENU	Back to Satellite list.
KEY_EXIT	Exit Main Menu.
KEY_RED	Enter Transponder Add menu
KEY_GREEN	Enter Transponder Edit menu
KEY_YELLOW	Enter Transponder Delete confirm menu
KEY_BLUE	Enter Transponder scan menu

Transponder Add menu



Operations in Transponder Add menu are shown in the following table

Option	Value
Transponder	Can't edit .Auto addition
Frequency	Press num key to edit
Symbol(ks/s)	Press num key to edit
Polarity	H,V

Transponder Edit menu



Operations in Transponder Edit menu are shown in the following table

Option	Value
Transponder	Current edit item.Auto select
Frequency	Press num key to edit
Symbol(ks/s)	Press num key to edit
Polarity	H,V

Transponder Scan menu



Operations in Transponder scan menu are shown in the following table

Option	Value
Scan Mode	Default,Network Search,Full Search
Channel Type	All,TV only
Service Type	All Services,Free Service
Polarity	Auto ,Vertical,Horizontal

3.2.7.3 Setting



Operations in Setting Menu are shown in the following table:

Key Stroke	Action
KEY_UP	use cursor to up
KEY_DOWN	use cursor to down
KEY_MENU	Back to Transponder list.
KEY_EXIT	Exit Main Menu.

Operations in Setting item menu are shown in the following table

Option	Value
LNB Type	9750/10600,9750/10750,05150,05750,5150/5750,09750,10600,10750,11300,11475,User Single,User Dual
LNB Power	On,Off
22KHz	Auto,off,on
DisEqC Mode	Off,LNB1,LNB2,LNB3,LNB4,Burst A,Burst B
Motor	None,DisEqC1.2,DisEqC1.3

Choose DisEqC1,2&1.3

Set Limit menu



Operations in Limit menu are shown in the following table

Option	Value
Move Continue	Control polar axis continually move east or west until it arrives where you want.
Move Step	Control polar axis move east or west at fixed step
Set East Limit	Set current position as the maximum angle eastward
Set West Limit	Set current position as the maximum angle westward
Goto Reference	Back to default values
Disable Limit	Repeal current set of limit values.

Set Location menu



Operations in Location menu are shown in the following table

Option	Value
Location	Select where user is or close to it, if user is not where system default sets, choose to Manual custom setting
Longitude Direction	Select user's region is east or west longitude
Longitude Angle	Select longitude where user is, move cursor and input corresponding data.
Latitude Direction	Select user's region is south or north longitude
Latitude Angle	Select latitude where user is, move cursor and input corresponding data.

Set Position menu



Operations in Position menu are shown in the following table

Option	Value
Move Auto	Select the direction of auto move is stop ,West or East
Move Step	Select the direction of step move is stop ,West or East
Store Position	Store the position which after moved
Goto Position	Go to the position which is stored
Goto Reference	Go to the reference position
GotoX	Go to the current satellite position

4. Feature Menu

This chapter will describe the function of Feature in mainmenu.

4.1 Feature Menu

Press "Menu" "Down(▼)" "Down(▼)" "Down(▼)" "Right(▶)" and then functions in the Sound can be set. The appearance of the Feature Menu is shown as follows:



Operations in Feature Menu are shown in the following table:

Key Stroke	Action
KEY_UP	Highlight the previous sub item. If it is the first button currently, then highlight the last one in the list.
KEY_DOWN	Highlight the next sub item. If it is the last button in the list currently, then highlight the first one.
KEY_LEFT	Back to mainmenu
KEY_RIGHT	If the focused item is "Timer", mainmenu will be closed firstly and then open the Timer Menu; If the focused item is " CI Info", mainmenu will be closed firstly and then open the CI Info Menu; If the focused item is " Hearing Impaired", a Popup Menu will be opened If not, Feature Menu will be closed firstly and then open the corresponding sub menus.
KEY_ENTER	Same as KEY_RIGHT.
KEY_MENU	Back to Main Menu.
KEY_EXIT	Exit Main Menu.

4.2 Function Description

4.2.1 Lock

The Lock sub page includes three parts: Lock Channel, Parental Lock, Change Pin Code as shown in the following picture.



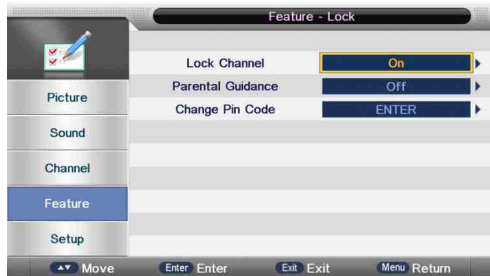

1) Operations in Lock Menu are shown in the following table

Option	Value
Lock Channel	On: turn on Lock Channel. User need to enter password to watch the channels which are locked. Also need to enter password when user tries to change settings in items like "reset system"/"reset database" etc. Off: turn off Lock Channel
Parental Lock	Off: turn off Parental Lock 4-18: turn on Parental Lock and set the age level that are permitted to watch the program.
Change Pin Code	KEY_RIGHT or KEY_ENTER to enter the pin code changing page.

2) Change Pin Code



3) Key Operation

Key Stroke	Action
KEY_NUM_0 ~ KEY_NUM_9	Press the numeral buttons to enter the password. If the entered numbers are not exactly the old password, then show a new password-enter menu to enter again. If they are right, then it will ask user to enter the new password that will take place of the old ones. If the New Password is the same as the Confirm New Password, it'll show a success message. If not, it will ask you to enter the new password.
KEY_MENU	Close the whole Main Menu
KEY_EXIT KEY_LEFT	Cancel pin-code-change-action and back to Child Lock Menu

4.2.2 Language

System language setting, includes OSD Language, Preferred Subtitle, Preferred Audio, Digital Teletext Language, Anglog Teletext Language



Option	Value
OSD Language	English, Italian, Spanish, Portuguese, French, German
Preferred Subtitle	English, French, German, Italian, Spanish, Portuguese, Danish, Czech, Dutch, Finnish, Swedish, Greek, Russian, Polish, Turkish, Norwegian, Welsh, Gaelic, TChinese, SChinese,
Preferred Audio	English, French, German, Italian, Spanish, Portuguese, Danish, Czech, Dutch, Finnish, Swedish, Greek, Russian, Polish, Turkish, Norwegian, Welsh, Gaelic,
Digital Teletext Language	English, French, German, Italian, Spanish, Portuguese, Danish, Czech, Dutch, Finnish, Swedish, Greek, Russian, Polish, Turkish, Norwegian, Welsh, Gaelic,
Anglog Teletext Language	West, Greek, East, Arabic, Cyrillic, Russian, Hebrew, Farsi

4.2.3 Clock

It is used to check out the current system time and set time zone/DST.



1) Range of the values of items in Clock Menu

Option	Value
Date	DD/MM/YYYY
Time	HH:MM
Time Zone	-12:00, -11:30, -11:00, ..., +00:00, +00:30,+01:00, ..., +12:00, Auto
DST(daylight saving time)	[On, Off] if it's " On ", it'll be an hour earlier than the GMT. If Time Zone is set to "Auto", it's not available.

2) Key-stoking action

Key Stroke	Action
KEY_UP	Highlight the previous sub item. If it is the first button currently, then highlight the last one in the list.
KEY_DOWN	Highlight the next sub item. If it is the last button in the list currently, then highlight the first one.
KEY_LEFT	Back to Feature Menu
KEY_RIGHT	Open/Close Popup Menu
KEY_ENTER	Same as KEY_RIGHT
KEY_EXIT	Exit Main Menu
KEY_MENU	Back to Feature Menu
KEY_STANDBY	Enter standby mode

4.2.4 Sleep Timer

When your TV is Running, start sleep function by setting Sleep Timer in any case. This function allows you to power off the TV within a period of time. Currently the supported time period are: Off, 10 Mins, 20 Mins, 30Mins, 60Mins, 90 Mins, 120 Mins, 180 Mins, 240 Mins,



4.2.5 Auto Power Off

When your TV is Running, start Auto Power Off function by setting Auto Power Off Timer in any case. This function allows you to power off the TV within a period of time. Currently the supported time period are: Off, 1 Hours, 2 Hours, 4 Hours.

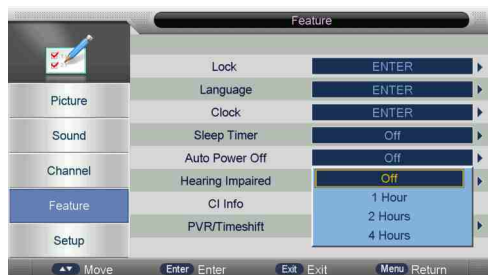

4.2.6 Hearing impaired

This function offers a subtitle such as a “stroke on the door” or “the bell starts to ring” for the current scene in case that the user is weak in hearing.



4.2.7 CI Info

It is only available in DTV source when PVR is not playing. Please refer to Chapter 6 section 2 CI Setup for further information about the function of CI.

4.2.8 PVR/Timeshift

For more information, Please refer to Chapter 6 section 3.

1) Range of the values of items in Clock Menu

Option	Value
Enable HDMI Link	On/Off
Auto Power On	On/Off
Auto Standby	On/Off
Speaker Preference	TV Speakers/Amplifier

2) Key-stoking action

Key Stroke	Action
KEY_UP	Highlight the previous sub item. If it is the first button currently, then highlight the last one in the list.

5. Setup Menu

This chapter will describe the function of Setup in mainmenu.

5.1 Setup Menu

The Setup Menu is shown as follows



The range and the default values of every sub items in Setup menu are shown in the following table:

Setup Menu Items	Value	Default
OSD Timer	(5, 10, 15, 20, 25, 30 Seconds, Never)	15
Auto SCART	Off/On	On
PC Setup	" ENTER "	
Blue Screen	Off/On	Off
Home Mode	Home/Dynamic/Standard/Mild	Home
Reset TV Setting	" ENTER "	
Software Upgrade	" ENTER "	

Operations in Setup Menu are shown in the following table:

Key Stroke	Action
KEY_UP	Highlight the previous sub item. If it is the first button currently, then highlight the last one in the list.
KEY_DOWN	Highlight the next sub item. If it is the last button in the list currently, then highlight the first one.
KEY_LEFT	Back to Main Menu.
KEY_RIGHT	If the cursor is on "OSD Timer" "Auto SCART", "Blue Screen", "Home Mode", a popup menu will appear for user to make further choice. If not, Setup Menu will be cleaned for other sub menus.
KEY_ENTER	Same as KEY_RIGHT.
KEY_MENU	Back to Main Menu.

5.2 Function Description

5.2.1 OSD Timer

Set up OSD Timer which means how long the menus will exist. The optional periods are 5, 10, 15, 20, 25, 30 Seconds.



5.2.2 Auto SCART

Switch for Auto SCART function.



5.2.3 PC Setup

It is only available in PC source.



Mode-Options	Value
Auto Adjust	"OK"
H Position	-16~16
V Position	-16~16
Phase	0~31
Clock	-50~50

- 1)Auto Adjust Auto Adjust the H Position, V Position, Phase, Clock
- 2)H Position Manually adjust H Position
- 3)V Position Manually adjust V Position
- 4)Phase Manually adjust Phase
- 5)Clock Manually adjust Clock

5.2.4 Blue Screen

It is not available in PC, DTV source or when it is not movie mode in multimedia source. In TV source, if there is no signal and Blue Screen is Off, it will show snow ; if there is no signal and Blue Screen is On, it will show blue screen.



5.2.5 Home Mode

Set up mode of Home Mode which can control the backlight. The optional modes are Home, Dynamic, Standard, Mild.



5.2.6 Reset to Setting

If the Lock Channel is On in Feature Menu/Lock , it needs to enter the password to enter the Reset. It will Reset System Setting and Database. When the reset is complete, it will enter the Auto Installation settings page. First, it will show a page to user to confirm. as follow.



5.2.7 Software Upgrade

Software upgrade by bin code. Put The bin code into the root directory of the media and media plugged into the TV 's USB interface, press ENTER key to upgrade. Don't power off during the upgrading process. The system will restarts when the upgrading process is done.

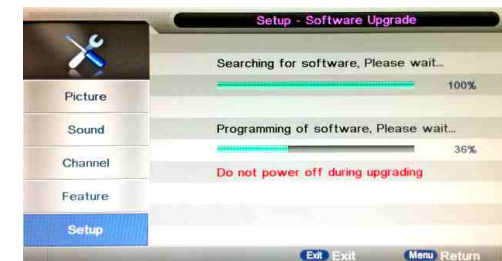

VI. Multimedia

1. Photo

1.1 Format Supported

Type	Container
PHOTO	JPG
	JPEG/Progressive JPEG
	BMP
	PNG

1.2 Function Introduction

Highlight the "PHOTO" item in multimedia mainmenu by press "RIGHT" / "LEFT" key, then press "ENTER" key enter photo page, as follow:



Key Operation

- 1) RED:Delete the focused folder/file.
- 2) GREEN:Add/Del all photo files to play list.
- 3) ENTER:Add/Del highlight files to play list.
- 4) CH+/-:Page up/Page down.
- 5) PLAY:Play the files in play list.

1.2.1 Playback

Press "PLAY" key to start playback.



Key Operation

- 1) : Same as "PLAY" key on remote, to start playing pictures in slide show mode
- 2) : Same as "PAUSE" key on remote, to pause the playing file
- 3) : Same as "STOP" key on remote, to stop sliding show, and return to the file browser
- 4) : Same as "|<< / >>|" key on remote, to play the previous or next file directly
- 5) : To rotate the playing picture(0 °, 90 °, 180 °, 270°).
- 6) : To zoom the playing picture.
- 7) : Same as "INFO" key on remote, to display the information of the current file.
- 8) : To enter "Photo Setup" menu, including "Repeat Mode", "Background Music", "Music Source", "Slide Time", "Effect".
- 9) : To enter the play list menu.

1.2.2 Thumbnails

- 1). Thumbnails mode can be shown only in photo mode and highlight in file browser by press "EXIT" "Right(▶)" as follow:



- 2). The direction keys are to move highlight in files.
- 3). Press "EXIT" key ,and press "LEFT" key, exchange to photo list mode.

2. Music

2.1 Format Supported

MUSIC	WAVE	LPCM ADPCM
	WMA	WMA STD WMA Prof
	AAC	AAC-LC / HE-AAC
	AC3	AC3 E-AC3
	MPEG	MP1 MP2 MP3 AAC-LC HE-AAC
	Read Audio	Cook
	Ogg	Vorbis
	FLAC	FLAC

2.2 Function Introduction

Highlight the "MUSIC" item in multimedia mainmenu by press "RIGHT" / "LEFT" key, then press "ENTER" key enter music page, as follow:



Key Operation

- 1) RED:Delete the focused folder/file.
- 2) GREEN:Add/Del all photo files to play list.
- 3) ENTER:Add/Del highlight files to play list.
- 4) CH+/-:Page up/Page down.
- 5) PLAY:Play the files in play list.

2.2.1 Playback

Press "PLAY" key to start playback.



Key Operation

- 1) : Same as "PLAY" key on remote, to start playing file, or resume the paused file.
- 2) : Same as "PAUSE" key on remote, to pause the playing file
- 3) : Same as "STOP" key on remote, to stop the playing file.
- 4) : Same as "<<" / ">>" key on remote, to play fast backward or forward. The speed can switch to twice, four times, eight times and sixteen times, and displayed with "X2 X4 X8 X16" on screen
- 5) : Same as "|<<" / ">>|" key on remote, to play the previous or next file directly.
- 6) : To switch the repeat mode, including "Repeat 1", "Repeat All", "Repeat Dir" and "Random" modes.
- 7) : To switch the window between "Information" and "Play List".
- 8) : Same as "BLUE" key on remote, to close the panel only in "MUSIC" mode, and then it can be opened by every key on remote.

3. Movie

3.1 Format Supported

Type	Container	Video Decoder
MOVIE	AVI	MPEG-4 ASP H.264 DivX Xvid WMV 9 / VC - 1
		MPEG-4 SP
		MJPEG
	MPEG 1/2	MPEG-1 Video MPEG-2 Video
	MPEG4	MPEG-2 Video MPEG-4 ASP H.264 Xvid MJPEG
	WMV	WMV 9 / VC-1
	RealMedia	RV30 / RV40
	Flash	Sorenson H.263 H.264
	QuickTime	MPEG-4 ASP H.264 MJPEG
	ASF	WMV3 / WVC1 MP4S / M4S2
	Matroska Video	MPEG-2 Video MPEG-4 ASP H.264 Xvid DivX DivX Plus HD RV30 / RV40 WMV9 / VC-1
	DivX	MPEG-4 ASP DivX Xvid
TS Stream	MPEG-2 Video H.264 WMV 9 / VC-1	

3.2 Function Introduction

Highlight the "MOVIE" item in multimedia mainmenu by press "RIGHT" / "LEFT" key, then press "ENTER" key enter movie page, as follow:

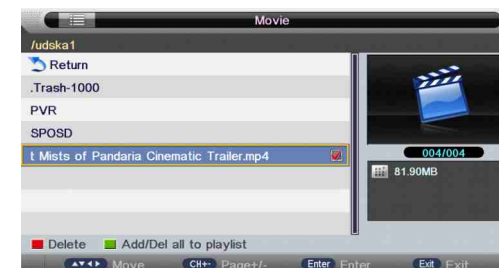

Key Operation

- 1) RED:Delete the focused folder/file.
- 2) GREEN:Add/Del all photo files to play list.
- 3) ENTER:Add/Del highlight files to play list.
- 4) CH+/-:Page up/Page down.
- 5) PLAY:Play the files in play list.

3.2.1 Playback

Press "PLAY" key to start playback.



Key Operation

- 1) [Play/Pause] : Same as "PLAY" key on remote, to start playing file, or resume the paused file.
- 2) [Pause] : Same as "PAUSE" key on remote, to pause the playing file
- 3) [Stop] : Same as "STOP" key on remote, to stop the playing file, and return to the file browser interface.
- 4) [Fast Backward/Forward] : Same as "<<" / ">>" key on remote, to play fast backward or forward. The speed can switch to twice, four times, eight times and sixteen times, and displayed with "X2、 X4、 X8、 X16" on screen
- 5) [Previous/Next] : Same as "|<<" / ">>|" key on remote, to play the previous or next file directly.
- 6) [Slow Mode] : To enter slow mode. The speed can switch to 1/2, 1/4, 1/8, 1/16, and displayed with "X1/2, X1/4, X1/8, X1/16" on screen.
- 7) [Step Mode] : To enter step mode.
- 8) [Repeat] : To set AB repeat, the first press sets A point, and the second press sets B point, and then play between A and B repeatedly.
- 9) [Playlist] : To enter the play list menu.
- 10) [Info] : Same as "INFO" key on remote, to display the information of the current file.
- 11) [Settings] : To enter "Movie Setup" menu, including "Program", "Subtitle", "Audio", "Repeat Mode".
- 12) [Go To] : To enter "GO TO" function, user can input the time he want to start directly.

4. eBook

4.1 Format Supported

Only txt format eBook is supported.

4.2 Function Introduction

Highlight the "eBook" item in multimedia mainmenu by press "RIGHT" / "LEFT" key, then press "ENTER" key enter eBook page, as follow:



Key Operation

- 1) RED:Delete the focused folder/file.
- 2) GREEN:Add/Del all photo files to play list.
- 3) ENTER:Add/Del highlight files to play list.
- 4) CH+/-:Page up/Page down.
- 5) PLAY:Play the files in play list.

4.2.1 Playback

Press "PLAY" key to start playback

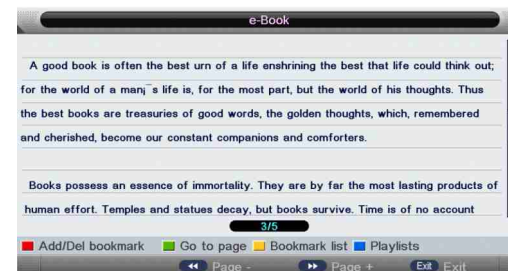

Key Operation

- "RED" To add/del bookmark.
- "GREEN" To input the page number directly.
- "YELLOW" To enter the "Bookmark list" page.
- "BLUE" To enter the "Play list" page.
- "<<" / ">>" To page down/page up.
- "EXIT" To close the file and return to the file browser.

VII. Other UI Setup

This chapter mainly describes the operation and the functions of the user interface besides mainmenu, such as EPG, CI Setup, Recorder, Timeshift, Playback and Auto Installation.

1.EPG

1.1 EPG abstract

If you expect to know the schedule or the information of the current playing program or the program that starts in the near future, you can refer to the EPG menu by pressing the button "EPG" on the remote. It shows the date and time on the top right of the menu, the list of the current available channels on the left side of the menu, and the name of each program that starts in a scheduled period of time on the right of the menu. Change the focused list by pressing "right" or "left", or the focused program by pressing "up" or "down". The information of the currently focused program will be displayed on the top of the menu.

There are 3 modes of EPG menu:

Daily mode: shows the information of the programs to be broadcasted in daily mode

Weekly mode: shows the information of the programs to be broadcasted in weekly mode

Extended mode: shows the detailed information of each program.

1.2 Daily Mode

- (1) Display the information of the programs that start in a scheduled period of time in the current channel. It includes name, start time, end time, short content description, current date/time, etc.
- (2) If the current focusing program is not parental locked, it will be played simultaneously in the background.



EPG Daily Mode

Key Stroke	Action
KEY_UP	Focus on the previous channel on the left channel list, and the focused event is the same as the last one where the focus existed.
KEY_DOWN	Focus on the next channel on the left channel list, and the focused event is the same as the last one where the focus existed.
KEY_LEFT	Focus on the earlier program on the right event list.
KEY_RIGHT	Focus on the later program on the right event list.
KEY_RED	Change to weekly mode
KEY_YELLOW	Update the program information of the current 7 channels in the channel list to the previous day and the start time keeps the same.
KEY_BLUE	Update the program information of the current 7 channels in the channel list to the next day and the start time keeps the same.
KEY_INFO	If the cursor lies on the right event list, change to Extended Mode by enter the key "KEY_INFO" or back to daily mode by enter the key "KEY_RETURN".
KEY_EXIT	Exit EPG.

1.3 Weekly Mode:

- (1) Display the information of the programs that start in a scheduled period of time in the current channel. It includes name, start time, end time, short content description, current date/time, etc.
- (2) Focusing on different channels on the left, it displays corresponding programs in schedule of time.
- (3) If the current focusing program is not parental locked, it will be played simultaneously in the background.



EPG Weekly Mode

Key Stroke	Action
KEY_UP	If the cursor lies on the left list, then the previous channel is focused. If the cursor lies on the right list, then the previous (earlier) event is focused.
KEY_DOWN	If the cursor lies on the left list, then the next channel is focused. If the cursor lies on the right list, then the next (later) event is focused.
KEY_LEFT	If the cursor lies on the left list, it moves to the list on the right. If the cursor lies on the right list, it moves to the list on the left.
KEY_RIGHT	If the cursor lies on the left list, it moves to the list on the right. If the cursor lies on the right list, it moves to the list on the left.
KEY_RED	Change to daily mode.
KEY_YELLOW	If the cursor lies on the left channel list, update the right event list to display the event information of the previous day. If the cursor lies on the right event list, update the right event list to display the event information of the previous day and move the cursor to the same place in the updated page.
KEY_BLUE	If the cursor lies on the left channel list, update the right event list to display the event information of the next day. If the cursor lies on the right event list, update the right event list to display the event information of the next day and move the cursor to the same place in the updated page.
KEY_INFO	If the cursor lies on the right event list, change to Extended Mode by enter the key "KEY_INFO" or back to weekly mode by enter the key "KEY_RETURN".
KEY_EXIT	Exit EPG

1.4 Extended Mode:

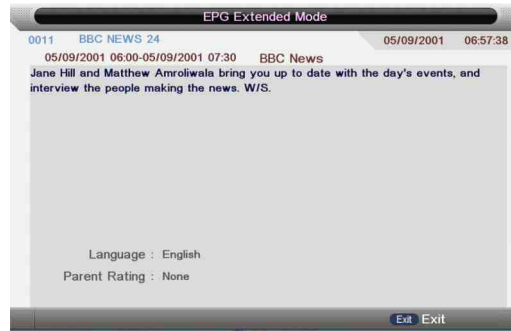

EPG Extended Mode

Key Stroke	Action
KEY_UP	If the information takes more than one page, the current page rolls up a row.
KEY_DOWN	If the information takes more than one page, the current page rolls down a row.
KEY_Exit	If it entered Extended Mode from daily mode, back to daily mode. If it entered Extended Mode from weekly mode, back to weekly mode.

2. CI Setup

2.1 Getting Access To Scrambled Channel

When a scramble-channel is selected, the user needs to insert a specific CAM and Smart Card. Otherwise it is not accessible and a popup menu appears to emphasize that it's a scramble-channel as the following picture shows.



Scramble Channel

Scramble-channel message

When a CAM is inserted and the system detects it, it will do some initialization and pop up a menu to let you know that CAM is initializing as the following picture shows:

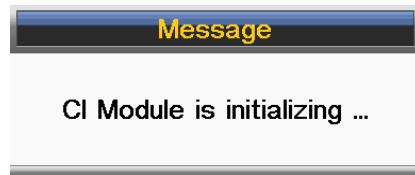

CAM initializing message

The scramble-channel can be accessible only under both of the following two conditions:
 (1) the CA system ID of the selected scramble-channel corresponds to the CAM and Smart Card that the user inserted;
 (2) the Smart Card belonging to the user is released after subscription..

2.2 Getting CI Information

When the CAM is in good connection with the system, enter main menu "Feature" -> "CI Info" to get CI Information as the following picture shows.



Getting CI Information

In the menu "Common Interface", all the information of CAMs which are in good connection with the system will be listed as the following picture shows. The listed items link to the CAM's CI Information.

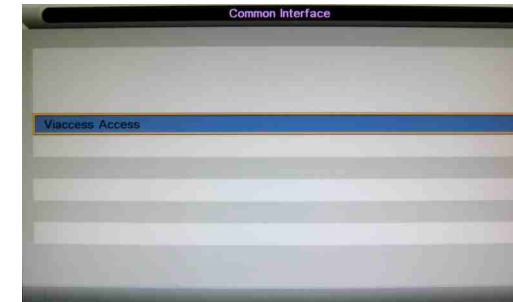

Link to CI Information

2.3 Details of CI Information

As mentioned before, items in the list link to the CAM's CI Information. But the way that its sub items are listed and the contents it offers differs according to different CA systems. Now we'll take a CAM from Viaccess Company as an example.

2.3.1 Main Menu

As the following picture shows:

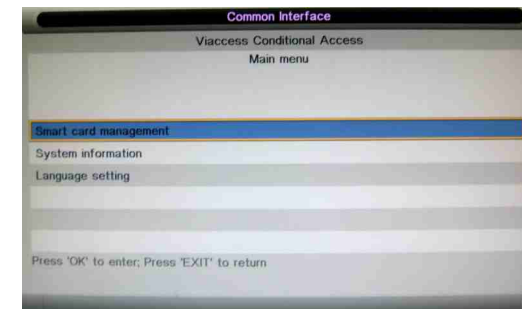

Main menu

2.3.2 Smart Card Management

Smart card management includes "subscription information", "morality level setting", "Change PIN code" and so on.

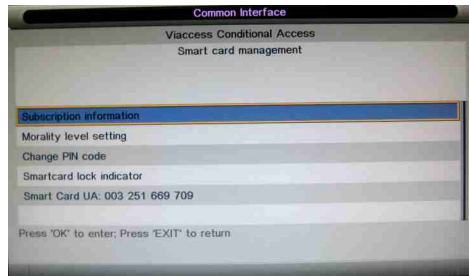

Smart card management

2.3.3 Subscription Information

Subscription Information lists all the subscribed services that registered in the smart card. Enter the sub item to look for more detailed information of a service.

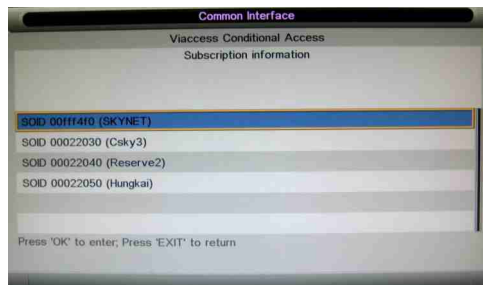

Subscription information

2.3.4 Morality level Setting

Morality level setting is used to shield programs those have a too high morality level to be open to child. Need to enter PIN code.

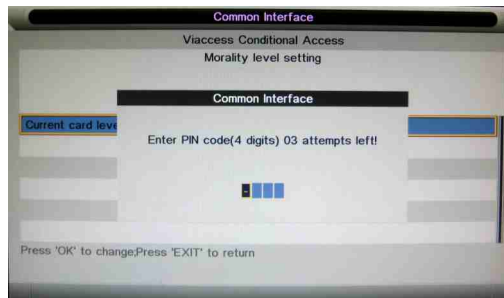

Morality level setting

2.3.5 Change PIN Code

User can change PIN code through operation on this sub item as the following picture shows.

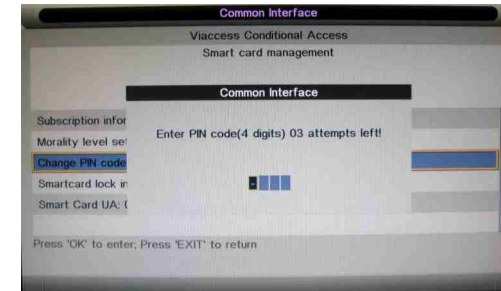

Change PIN code

2.3.6 System Information

System information means information about CAM such as software/hardware version.

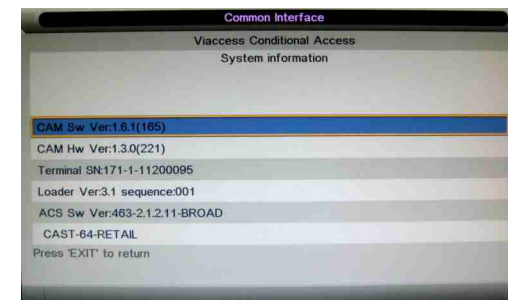

System information

2.3.7 Language Setting

Language setting menu shows all the OSD languages the CAM supports. After selection on some language, all the strings are turned into the selected language under the condition that the system (CV512 series) supports it. Otherwise there is to be some unrecognized characters.

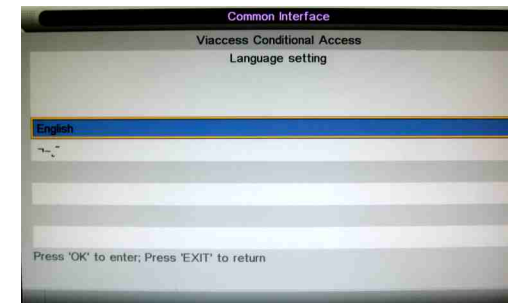

Language setting

2.3.8 Others

The way that sub items of the CI Information are listed and the contents it offers differs according to different CA systems and becomes more and more complicated with the increase of DTV broadcast systems in the future.

3. PVR For Euro DVB-T2/C/S2 Only

This section is to introduce some contents about PVR, including PVR involved menus, Recording flow, Recorders playback, Recording restrictions.

3.1 PVR involved Menus

1. PVR/Timeshift menu;
2. Partition List menu;
3. Timer menu;
4. Timer Edit menu;
5. Record List menu;
6. REC info menu;
7. Timeshit info menu.

3.1.1 PVR/Timeshift menu

Information: PVR/Timeshift menu manages almost all the information that have relationship with PVR.

Enter method: Main menu feature PVR/Timeshift PVR/Timeshift menu;
Menu shows as follows:



(PVR/Timeshift menu)

Function list explain:

Items	
Partition Select	Enter Partition Select menu
	Display partition' s infomation
	Format partition function
	Set default partition function
Auto Timeshift	Auto Timeshift off Stop auto Timeshift Auto Start auto Timeshift
Timeshift Buffer	Set Timeshift Buffer auto 30Mins 1hr 2hr
Timer	Enter Timer menu
	Preengaged programs' information
	Add delete preengaged programs
Record List	Enter Record List menu
	Display Recorders' information
	Playback Recorders

(PVR/Timeshift menu Key Stroke)

Key Stroke in menu:

Key Stroke	Action
KEY_UP	Focus on the previous option on the left function list.
KEY_DOWN	Focus on the next option on the left function list.
KEY_LEFT / KEY_MENU	Return to the previous menu's focus.
KEY_RIGHT / KEY_ENTER	Focus on the later menu on the left function list.
KEY_Exit	Exit all menu.

3.1.2 Partition List menu

Information: Partition List menu manages the partitions connected to system.

Enter method: PVR/Timeshift menu Partition Select Partition List menu.

Menu shows as follows:



(Partition List menu)

Function:

- a) Partitions: The list in the menu shows the partitions connected to system
- b) Partitions' property: Total size and Free size
- c) Format Partition: Press KEY_RED to format the focus partition. Before format, there is a prompted popup window to confirm. If format successfully there is a message "Format Success!", otherwise, there is a "Format Fail!"
- d) Set default partition: Press KEY_GREEN to set the focus partition as the default partition . The recorders are stored in the default partition. It need to be reset if the default partition is full in recording progress.

Key Stroke in menu:

Key Stroke	Action
KEY_UP	Focus on the previous option on the partition list.
KEY_DOWN	Focus on the next option on the partition list.
KEY_MENU	Return to the previous menu's focus (PVR/Timeshift menu "Partition select" option).
KEY_RED	Format the chosen partition.
KEY_GREEN	Set the chosen partition as the default partition.
KEY_Exit	Exit all menus.

(Partition List menu Key Stroke)

3.1.3 Timer menu

Information: Timer menu manages the preengaged programs, user can add delete preengaged programs in this menu.

Enter method:

- PVR/Timeshift menu Timer Timer menu;
- Press KEY_CLOCK to enter Timer menu when there is no menu focused.

Menu shows as follows:



(Timer menu)

Prompted information explain:

- CH NO. :Channel number;
- Channel :Channel name;
- Start : Start recording time;
- Duration :The total recording time;
- Date : The date of starting recording;
- Mode : Record Mode;
- On the left top of menu is current date and time in system.

PS:

- These information except "g" all come from the preengaged programs in Timer Edit menu or EPG;
- Pressing KEY_YELLOW for add or KEY_BLUE for edit could enter Timer Edit menu. Press KEY_RED to delete the focus program, press KEY_GREEN to delete all the programs.

Key Stroke in menu

Key Stroke	Action
KEY_UP	Focus on the previous option on the record list.
KEY_DOWN	Focus on the next option on the record list.
KEY_RED	Delete the chosen program.
KEY_GREEN	Delete all the programs.
KEY_YELLOW	Add recording program; Enter Timer Edit menu.
KEY_BLUE/ KEY_ENTER	Edit the chosen recording program; Enter Timer Edit menu.
KEY_MENU	Return to the previous menu's focus (PVR/Timeshift menu "Timer" option).
KEY_Exit	Exit all menus.

(Timer menu Key Stroke)

3.1.4 Timer Edit menu

Information: User could set, modify preengaged programs' information in Timer Edit menu.
Enter method: Timer menu→KEY_YELLOW for add or KEY_BLUE/KEY_ENTER for Edit → Timer Edit menu.

Menu shows as follows :



(Timer Edit menu)

unction explain:

- Recorder : Off、 On . "Off" means to preengage program for watching only, "On" means to preengage program for watching and recording.
- Type: DTV、 Radio, DTV means to preengage DTV Channel program and Radio means to preengage Radio Channel program;
- Channel: DTV or Radio Channel programs;
- Start Time: Start recording time; Format is hour / minute ;
- Duration: The total recording time ; Format is hour / minute ; PS:The status of this option is disable, only when Recorder is "On", it can be set;
- Date :The date of starting recording, Format is day / month / year;
- Mode : Once、 Daily、 Weekly、 Month;

PS:

- The start recording time must be reasonable (behind current system time): If the timer is repeat or not reasonable, there will be a message "Set timer fail!" to prompt when return;
- The Edit function resemble Add function except that Type and Channel can not be changed again.

Key Stroke in menu

Key Stroke	Action
KEY_UP	Focus on the previous option on the Edit list.
KEY_DOWN	Focus on the next option on the Edit list.
KEY_0~9	Edit Start Time Duration Date.
KEY_ENTER	Confirm the choice.(For popList options)
KEY_MENU	Return to the previous menu (Timer menu) and save the setting.
KEY_Exit	Exit all menus.

(Timer Edit menu Key Stroke)

3.1.5 Record List menu

Information: Record List menu manages the Recorded programs. User can playback recorders in this menu.

Enter method:

PVR/Timeshift menu Record List → Record List menu.

Menu shows as follows:

Record List		
0001	TF1 HD	2009/04/03 00:05:20-00:08:02
0002	BBC ONE	2001/09/05 06:57:12-07:00:31
0003	BBC TWO	2001/09/05 06:56:58-06:58:10
0004	BBC ONE	2001/09/05 06:59:00-07:03:03

Record List menu

Key Stroke in menu

Key Stroke	Action
KEY_UP	Focus on the previous option on the program list.
KEY_DOWN	Focus on the next option on the program list.
KEY_ENTER	Play the focus program.
KEY_MENU	Return to the PVR/Timeshift menu (focus on Record List option).
KEY_Exit	Exit all menus.

(Record List Key Stroke)

3.1.6 REC info menu

REC input info menu:

Information: REC input info menu displays as a flag of REC. After REC start this menu displays all the time until REC stop (except there is some other menu exist).

Enter method: After REC start, it will display automatically.

REC info banner menu:

Information: REC info banner shows some current recorder's information. Actually REC info banner shows different information with Timeshift info banner.

Enter method: After REC start, press KEY_DISPLAY to show the REC info banner menu.

Function explain:

- Time is equal to current REC time minus REC start time.
- Progress bar is for current REC length compared with the disk free space when REC start.
- MB Free is the disk instantaneous free space.

Menu shows as follows

0800 TF1 HD	MB Free : 6027
00:06:28	

(REC info menu)

Key Stroke in menu:

Key Stroke	Action
KEY_PAUSE	Start or pause recording.
KEY_DISPLAY	Enter banner info menu.
KEY_STOP	Stop REC.

(REC info Key Stroke)

3.1.7 Timeshift info menu

Timeshift input info menu:

Information: Timeshift input info menu displays as a flag of Timeshift. After Timeshift start this menu displays all the time until Timeshift stop (except there is some other menu exist).

Enter method: After Timeshift start, it will display automatically.

Timeshift info banner menu:

Information: Timeshift info banner shows some current Timeshift information.

Enter method: After Timeshift start, press KEY_DISPLAY to show the menu.

Function explain:

- Time is equal to current play time minus current recording time.
- Progress bar is for current recording length compared with the disk free space when REC start. The black triangular icon is for current play length compared with current recording length.
- MB Free is the disk instantaneous free space.
- The right red time menu has the same function with the time in info banner menu (only when info banner menu closed it showed).

Menu shows as follows:

0801 France 2 HD	MB Free : 5619
-00:00:46	

(Timeshift info menu)

-00:00:46

(Timeshift time menu)

Key Stroke in menu:

Key Stroke	Action
KEY_PAUSE	Start or pause recording and playing.
KEY_DISPLAY	Enter banner info menu and close time menu.
KEY_STOP	Stop Timeshift.
KEY_FF	Playing video fast forward with speed "x2", "x4", "x8", "x16"
KEY_FB	Playing video fast behind with speed "x2", "x4", "x8", "x16"

(Timeshift info Key Stroke)

3.2 REC

This section is for recording flow.

3.2.1 REC

1.Information

- a) Input MPEG2 TS, NIM, ISO/IEC 13818-2, H.264;
Output MPEG2 PS packet, only contain Video and Audio PID, no Teletext, Subtitle, EPG etc, the output Video file format is ".MPG" and Audio file format is ".MP3", the output files can be played by other players which supports MPEG2 PS; TS packet, contain Video and Audio PID, Teletext, Subtitle etc, the output Video file format is ".TSV", the output files can be played by other players which supports TS
- b) The save direction for the output files: the inserted storage device (USB/Card). If user wants change the output direction, he can open the partition list by pressing the button "Device" and make the choice. It supports 4 partitions at most;
- c) The rules of naming the output files: Program name + (REC date_time(h/m/s), eg BBC ONE(20111023_123456).MPG. If a long-time recorded file takes more than 3.9GB, it cuts and makes a new file named by adding an extra sequence number. eg: BBC ONE (20111023_123456)001.MPG.

2. Recording Flow

- a) Set up the working partition (default partition): (This step is adapt to Timeshift also)
 - 1) There is a Partition list shows the partitions connected to the system in Partition List menu, Press KEY_GREEN to set the focus partition as default;
 - 2) System will set the partition which is recognized firstly as default partition before record if user does not set before;
 - 3) Recorded files will be stored in the default partition.
- b) Press KEY_REC to start recording, when there is a program playing, it will pop up a message "Do you want to start Recording?". After confirm, the system will read the speed of the storage device. If the speed is too low for recording, there is a message "Device speed not enough, RECORD anyway?" if user choose Yes, it will record constrainedly. In addition, the speed is high enough, it initializes in the first instance and starts to record later.



(Confirm record window)



(Initializing recorder window)

- c) As the initialization successfully ends, a REC input info menu appears on the right top corner of the picture and it starts to record while the program is playing in the background;
- d) Press KEY_DISPLAY to get the current recording information from the Info Banner, such as current recording time and the recording progress. The recording time depends on how much of the program has been recorded actually;
- e) If the signal is not stable there may be some pause;
- f) The recording progress will stop when the device has no more free spaces if there is no setting about when to end before. A warning message pops up, the recording process stops and it will keep on the normal playback process. Otherwise the progress ends naturally when the timer is timeout. Also user could press KEY_STOP to end recording manually;
- g) System will prompt user error message and try to continue recording if there are some bad tracks in disk.



(REC info and stop recording window)

3.2.2 Timer REC

There are two methods to set a timer. As follows:

1. In the EPG menu user can preengage programs for watching or recording;
 - a) Pressing KEY_GREEN once is to preengage the program only for watching (when timeout, it jumps to the program and only play).
 - b) Pressing KEY_GREEN twice is to preengage the program for recording (when timeout, it jumps to the program and starts recording). if it is timeout in standby mode, it will power on 2 minutes in advance and starts to record under background without powering on the panel. To watch the program, user need to press KEY_POWER;
 - c) The preengaged programs can be checked in Timer menu.



(Press KEY_GREEN once for reminder)



(Press KEY_GREEN twice for recorder)

2. In Timer menu, user can increase, delete preengage programs; In Timer Edit menu, user could set, modify preengaged programs' information;
In Timer menu: press KEY_YELLOW to get into Timer Edit menu to add a timer. Then set timer's information in Timer Edit menu.

Flow of setting a timer's information:

- Type: Set program type :DTV or RADIO;
- Mode: Way of triggering a timer(once/daily/weekly/monthly);
- Recorder:"ON": preengage for watching and recording(record). "OFF": preengage only for watching(reminder);
- Set the date/time and Duration time (exact to minutes): Must be reasonable (behind current time);
- Timer: when there are some conflicts a warning message will pop up;
- Press KEY_MENU to return to Timer menu and store the timer's information.



(Timer Edit men)

- When the timer recorder is timeout, it jumps to the very channel and starts to record the program automatically.(if a manual recording is under process, it will stop the manual recording process and starts the timer recorder automatically);When there is left 10s before recorder , a prompted window will pops up;

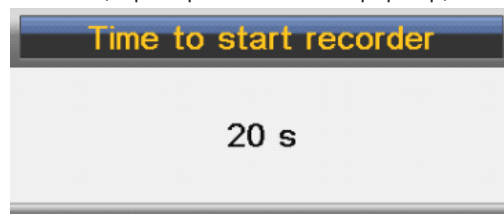

(Timer Record start prompt window)

- If there are not any storage media, the settings fail and a warning message "no USB device" shows;
- If target partition (default partition) is not set, it selects the first partition that the system identified automatically.

3.2.3 Timeshift

Timeshift can record program and play the current recording program at the same time.

- Set Timeshift Buffer in PVR/Timeshift menu, Timeshift Buffer means how long a recorder can be stored when Timeshift. If Buffer is overstepped , the previous recorder stored there will be lie over; There are three modes: auto、30Mins、1hr、2hr,"auto"means all the free spaces on the storage media;
- In the normal playback process in DTV source, there are two ways to start timeshift:
 - Manually: press KEY_PAUSE to start Timeshift when there is no menu focused (Stop: press KEY_STOP);
 - Automatically: set the "Auto Timeshift"option as "Auto" in PVR/Timeshift menu (Stop: set "Auto Timeshift"as "Off").
- Before Manually Timeshift, there is a message "Do you want to start Timeshift". After confirm,If signal is stable, it will check whether the speed of the storage device that the user inserted is enough for Timeshift. If the speed is not enough, a warning message will pop up to let the user make decision whether to go on. If timeshift is force to take place,

there may be some pause or mosaic. Otherwise the speed is enough for Timeshift, it'll take place under background and users are able to pause or move fast backward: After a pause, users are able to pause or move fast backward;

- After Automatically Timeshift, it will take some minutes to initialize, then it take place automatically;



(Timeshift Play start prompt menu)



(Timeshift Play Info menu and stop prompt)

- A UI (Timeshift time menu) on the right top corner shows the fallen time between the current picture and the living broadcasting picture;
- During the recoding progress, if the signal is missing, the recording process will take a pause until the signal is stable again.

3.3 REC Playback

Play videos and recorded files

- The recorded Videos can be played in Record List menu , in Record manage menu or in Source Media Movie mode;
- When a video playing, the Info Banner menu shows the length of the video and the time that the video has been played. Also there is a progress bar indicating the process of playing the video;
- A playing video can move fast forward with the speed "x2", "x4", "x8", "x16" or play in a normal speed by pressing the button "fast forward";
- A playing video can move fast backward with the speed "x2", "x4", "x8", "x16" or play in a normal speed by pressing the button "fast backward";
- If it moves fast backward to the start of the video, it turns into the normal playing speed automatically;
- When a video playing, pause the process by pressing the button "pause/play" and restart the process by another press again;
- When a video playing, it can jump to the previous or the next video to play by pressing the button "previous" or "next";
- When a video playing, user can stop the process by pressing the button "stop" and it goes back to the browser in movie mode;
- When it comes to the end of a video, it will stop/repeat/play the next one depending on the value of Repeat mode.

PS: The 3、4、5、6、7、8 upwards also adapt to the playback when it is recording.

3.4 Restriction

3.4.1 Device & File System

- The USB host supports version 2.0 and is compatible with version 1.1, but it can't support card reader and USB Hub, neither Timeshift and timer recorder on USB 1.1.

2. Support Timeshift on programs which have a equal or lower rate than 8Mbps and support recorder on programs which have a equal or lower rate than 13Mbps(13Mbps is a test result of SAM USB2.0 High speed 320G).
 3. Restrictions on USB device for Recorder:
 - a) For programs which have a lower rate than 8Mbps, the USB device must have a rate higher than 14Mbps in CV512 speed test for Recorder and higher than 28Mbps in CV512 speed test for Timeshift. Otherwise there may be some pause or mosaic when do Recorder or Timeshift by force;
 - b) For programs which have a higher rate than 8Mbps, the USB device must have a rate higher than 20Mbps in CV512 speed test for Recorder and Timeshift is not supported. Otherwise there may be some pause or mosaic when do Recorder or Timeshift by force;
 4. The USB device's file system supports FAT32 / FAT/NTFS;
 5. The system supports 4 partition connection at most at the same time;
 6. The same partition is able to store 9999 recorded files at most, namely the biggest number of files is 9999;
 7. The maximum size of a single file the system supports is 4GB at present. When long-time recording, the file will be cut to creat a new one automatically when its size reaches 3.9GB;
 8. FAT file system supports 4GB every partition at most while the FAT32 file system supports 1TB at most;
 9. The system can support USB flashdisk and removable disk at present. However, it can not sure that all kinds of them could record or write into the storage very smoothly, especially when the file system is in disorder. If users are opt to use a USB flashdisk as the storage media, it is recommended to format the disk before us;
 10. It will take a brief test on the speed of the USB device and then show a warning message when the speed is not enough.
- 3.4.2 Power Lost or Device Disconnect
1. System powering off, the inserted device powering off or unexpected connection failure during the recording process may cause substantial damage to the device or make underlying mistakes to the file system;
 2. Abnormally interrupted recorded files are unable to be played, but after reconnection between the device and the system, it will recover automatically while it is setting up partition;
 3. The file-recover function: it can recover the file from recorder starting to 2 minutes before the interruption happens. If the length of the damaged file is shorter than 2 minutes, the file can not be recovered again and will be deleted automatically. (the length depends on Video bit rate and the minimum configured unit of the partition.

4. Auto Installation

If this is the first time you are turning on the TV and there are no programs in the TV memory, he "Auto Installation" menu will appear on the screen. There are 5 setups as follow:

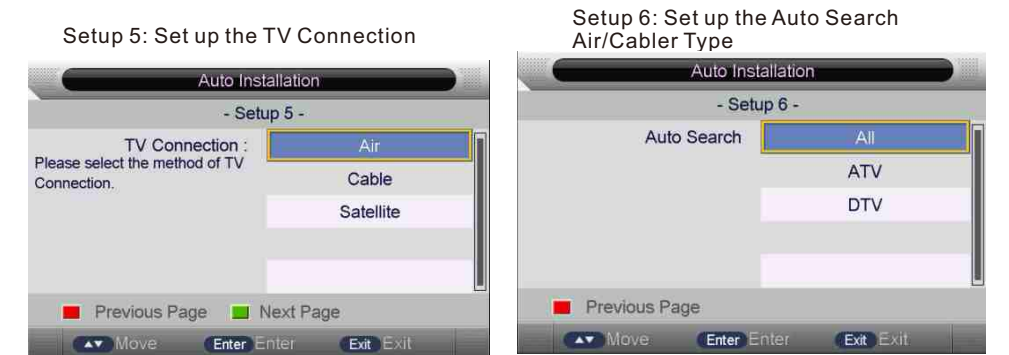
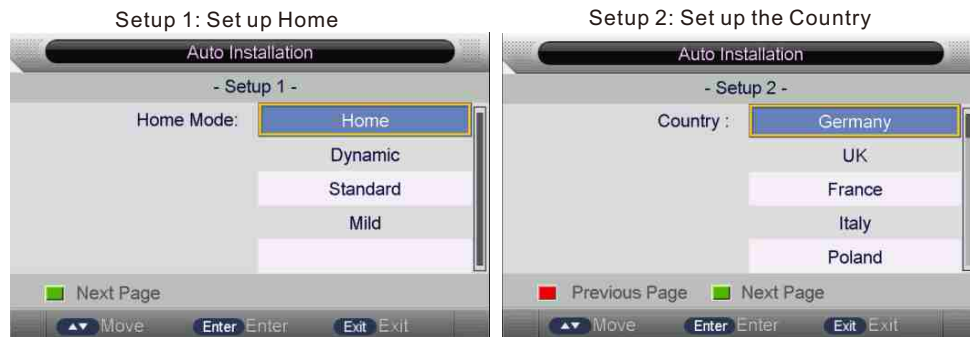

Operations in Setup 6 Satellite type are shown in the following table

Option	Value
DataBase Import	Inport default Satellite database
Satellite System	Enter Satellite System menu for setting

5. Channel list menu



Key Stroke in menu:

Key Stroke	Action
KEY_UP	Focus on the previous item program
KEY_DOWN	Focus on the next item program
KEY_MENU	Exit menu
KEY_CHANNEL_LIST	Exit menu
KEY_RED	Show Find mode menu

6. Fav list menu



Key Stroke in menu:

Key Stroke	Action
KEY_UP	Focus on the previous item program
KEY_DOWN	Focus on the next item program
KEY_MENU	Exit menu
KEY_FAV_LIST	Exit menu
KEY_RED	Show Rename Fav list name menu

7. USA TV OSD Operating manual

7.1. Time submenu

7.1.1 Appearance

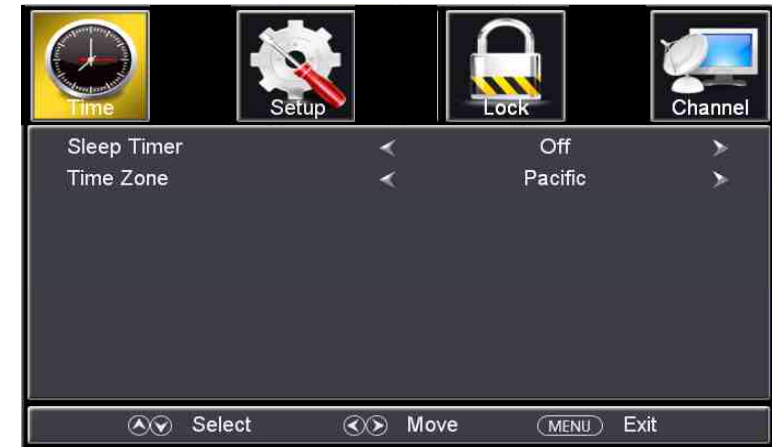

7.1.2 Function introduction

Item	Variable range	Default	Explanation
Time Zone	Pacific/Alaska/Hawaii /Eastern/Central/Mountain	Pacific	Default value can be modified according to client's requirements.
Daylight Saving Time	Off/On	Off	Only adjustable under DTV channel.

7.2. Setup submenu

7.2.1 Appearance



7.2.2 Function introduction

Item	Variablerange	Default	Explanation
Menu Language	English/ French /Spanish	English	Now there are only three kinds of language for OSD, if clients need more, we can add the
Closed Caption			You can enter CCD submenu through this option, menu pattern and function explanation
DCL	On/Off	On	Dynamic brightness control
Restore Default			For this operation, first confirm which options need to be restored according to client's requirements. We need to have one default standard. Menu pattern please refer to 4.2.4.3.5

7.3. Lock submenu

7.3.1 Prompt menu for entering password



Note:

Input the correct password with four numbers (from 0-9), then you can enter the next level menu (default password: 0000). If the password is wrong, then there will be prompting information in the middle of the menu.

7.3.2 Lock menu



7.3.3 Function explanation:

Item	Variablerange	Default	Explanation
Change Lock			Enter the menu for user to define the password
System Lock	Off/On	Off	Main switch of VCHIP, if it is OFF, then US and Canada will be grey.
US			US VCHIP setting, enslaved to System Lock option
Canada			Canada VCHIP setting, enslaved to System Lock option
RRT Setting			Only when the system detects DTV code stream with RRT information then you can enter submenu, or, it will be grey.
Reset RRT			RRT reset.

7.4 Channel submenu

7.4 .1 Channel



7.4.2 Function explanation

Item	Variable range	Default	Explanation
Air/Cable	Air/Cable	Air	
Auto Scan			Enter submenu of automatic searching,
Favoite			User defines his Fav channel, before searching it is grey and can't be used.
Show/Hide			User defines the channels need to skip, before searching it is grey and can't be used.
Channel No.	Among all the channels searched		
Channel Label			Enter the menu of the channel defined by user.
DTV Signal			Dynamic display the intensity of DTV signal, it is always grey and can't be selected.

VIII. Built-in DVD Player Operation

General disc informaiton

The following types of disc can be played on this unit:



DVD video discs

DVD video discs are divided into titles, and the titles are subdivided into chapters.

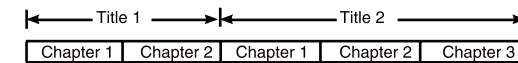

You may find the following markings on DVD video discs; they are explained below:

	Multiple languages
	Multi-language subtitles
	Multi-angle
	Multi-aspect
	Closed captions

Audio CD discs

Audio CD discs are divided into tracks:

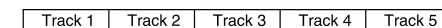

CAUTION:

- Only the types of disc mentioned on the previous page can be played on this unit; DVD-ROM, CD-ROM, CVD, VCD etc. cannot be played back.
- A DVD-RW (video mode) can generally be played back, but not necessarily all DVDs of this type: playback capability depends on the recording conditions.
- A DVD-RW (VR mode) cannot be played back.
- A DVD+R/+RW can generally be played back, but not necessarily all DVDs of this type: playback capability depends on the recording conditions.
- A DVD-R that has recorded movie data can generally be played back on this unit, but not necessarily all DVDs of this type: playback capability depends on the recording conditions.
- A DVD-R without any recorded movie data cannot be played back.

Handling, storing and cleaning discs

- Never put anything except a 12cm DVD (or CD) into the disc slot. Foreign objects can damage the unit.
- Carefully wipe any fingerprints and dust from the signal surface of the disc (glossy side) with a soft cloth. Wipe straight from the center to the outside of the disc.
- Never use chemical cleaning spray, liquids or solvents to clean discs. These chemicals will permanently damage the plastic surface of the disc.
- To remove a disc from its storage case, press down on the center of the case and lift the disc out, holding it carefully by the edges.
- Return any discs to their cases after use to protect them from dust and scratches.
- To prevent warping the disc, do not expose it to direct sunlight, high humidity or high temperatures for extended periods of time.
- Do not apply paper labels or write anything on either side of the disc. Sharp writing instruments, or the inks used in some felt-tip pens, may damage the surfaces of the disc.

DVD set up

Once you have made your initial settings, you can always operate the unit under the same conditions. The settings will be retained in the memory until they are changed, even if the power is turned off.

NOTE:

- Press [DVD SETUP] to activate the DVD player OSD menu.
- Press ◀/▶ to highlight and move between different sub-menus, then press ▼ to enter the sub-menu.
- Press ▲/▼ to move the highlight to the item you wish to select, then press ▶ to enter.
- Press ▲/▼ for adjustments.
- Press [DVD SETUP] to exit the OSD menu

INITIAL SETTINGS (DVD)

General Settings page

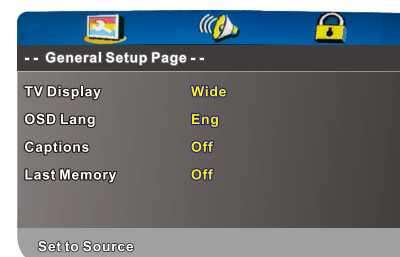

1. TV DISPLAY: Set the screen ratio options are: Normal/PS (4:3 Pan Scan), Normal/PS (4:3 Letter Box) and Wide (16:9). The default settings is wide.

2. OSD Lang: Set the OSD Language options.

3. CAPTION: Play captions on supported DVD titles, Options: ON/OFF.

4. LAST MEMORY: Play DVD from last point. Options are: ON/OFF.

Audio Setup Page

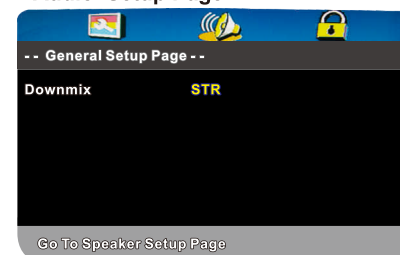

1. LT/RT: Logic Surround stereo audio output. This matrix-based coding process enables stereo audio tracks to carry four channels (left, center, right and surround) of audio data.

2. Stereo: Analog stereo audio output. The player sends the subwoofer and speech signals to the Tv's speakers.

Preference Page



1. TV Type: The DVD player supports output of various systems including Multi, NTSC, PAL. The default setting is PAL and this should not need to be changed.

2. Audio: DVD language selection options.

3. Subtitle: This player can display DVD subtitle languages if supported by the DVD disc. When playing DVD's, you can hide the subtitle or choose any of them as the current subtitle language.

4. Disc menu: DVD Disc menu language selection options.

5. PARENTAL This function disables playback of specific DVD's which may be unsuitable for children. Some DVDs are encoded with specific rating levels. If the rating level of the disc is higher than that preset in this menu, playback of the disc will be prohibited. After selecting one of the PARENTAL codes, the screen will display the PASSWORD page. The default password is "8888".

6. PASSWORD [DVD only]: Allows you to change the current PASSWORD.



7. Default: This option will return the DVD to it's factory default settings.

Basic playback functions

If this symbol  appears on the TV screen during operation, the function you are trying to access is currently not available on the disc.

1. Turn on the TV and press [SOURCE] to select the input source as DVD.
2. Insert the disc (label facing away from you) into the disc slot (side panel) approx 1/3 of the way in until you feel tension from the disc mechanism. Shortly after the mechanism will continue loading the disc all of the way in. DO NOT FORCE THE DISC IN. The TV will start playing the first file/track/chapter automatically.





NOTE: Regardless of the mode you have selected, when you insert a playable disc into the disc slot, the TV will switch to DVD mode and start playback automatically

3. To temporarily stop playback of a CD, press  to stop playback, press it again to resume playback.
To temporarily stop playback of a DVD, press  once to stop playback, press it twice to stop playback completely.

Selecting a DVD menu

NOTES: The operation may differ depending on the disc used.

Selecting a menu may not be possible on some discs.

1. Press [DVD MENU] during playback, the main menu screen will appear.
2. Press  /   /  (or the number buttons) to select the desired menu.
3. Press [OK] and the selected menu playback starts.

Chapter (track) skip

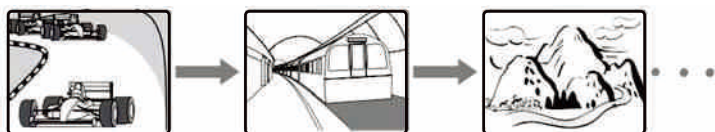

Skipping forward

Press  during playback to skip to the next chapter (or track).

Skipping backward

Press  during playback to skip back to the previous chapter (or track).

NOTE: You can skip only through the chapters, not through the title on the DVD disc.



Title Search [DVD]

Press [GOTO], then press the number buttons to enter the desired title number.

Repeat Playback

Press [REPEAT] during playback to activate repeat mode:

DVD



If you want to ...	Press [REPEAT] ...
Repeat chapter ( Chapter)	Once
Repeat title ( Title)	Twice
Repeat all ( All)	Three times
Repeat O?	Four times

CD

If you want to ...	Press [REPEAT] ...
Repeat current track	Once
Repeat all tracks	Twice
Repeat off	Three times

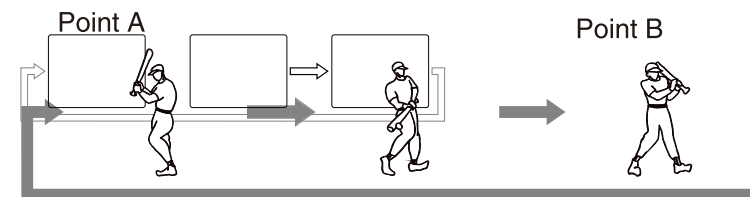
A-B repeat (designated range repeat playback)



1. Press [A B] during playback at the beginning of the section you want to repeat (Point A). " A" appears on the TV screen.
2. Press [A B] again at the end of the section you want to repeat (Point B). " AB" appears briefly on the TV screen.
3. To return to normal playback, press [A B] again.

Important note

The DVD **default password is "0000"** — you need that to enter the password/lock menu so that you can set your own password. If you forget the password you have set, you have to enter the **master password: "8888"**. This will clear your set password and go back to the default password, which you can change, if you wish.

Subtitle language [DVD]

If the DVD you are watching has subtitles, press [SUBTITLE] repeatedly during playback until the desired subtitle language appears on the TV screen. Example: SUBTITLE 01/03 ENG

NOTE: Not all discs support this function.



Audio soundtrack language (multilanguage) [DVD]

This function works only with discs that have multiple audio soundtrack languages recorded.

Press [AUDIO] repeatedly during playback until the desired language appears on the TV screen.

NOTES:

- When the desired language is not selected, even though the button is pressed, the language is not available on the disc.
- If the language is not recorded on the disc, only the available language on the disc will be heard.
- When you turn off the power or change the disc, you have to select the language again.

On-screen information

Press [DISPLAY] repeatedly to show the disc information available (Title, Chapter, Title elapsed playing time, Language, etc.).

Picture/JPEG CD playback

To start a slide show from the thumbnail pictures:





1. Press ▲ / ▼ / ◀ / ▶ to select the desired picture.

To go to the next or previous thumbnail pictures, press ►► or ◀◀.

2. Press [OK] or /▶ (Play) to start the slide show from the selected picture. During the slide show:

- PRESS || to pause. Press ▶ (Play) to continue.
- PRESS ►► or ◀◀ to skip to the next or previous file.
- If the picture appears upside down or sideways, press ▲ / ▼ / ◀ / ▶ to flip/rotate the picture.

X.Troubleshooting

Problem	Possible cause	Possible solution
No picture and sound.	<ul style="list-style-type: none"> • The power adaptor is not plugged in or not working. • The wrong input source is selected. • The input source has failed to connect with the TV or is not turned on. 	<ul style="list-style-type: none"> • Plug the power adaptor into a suitable outlet. Try both the 12/24V & 240V adaptors • Select the correct input source. • Make sure the input source is correctly connected and turned on.
No sound.	<ul style="list-style-type: none"> • The volume control is set to minimum. • The mute  button on the remote control has been pressed • An incorrect sound system mode is set. 	<ul style="list-style-type: none"> • Press the  button to increase the volume. • Press  or the (or ) button to restore/increase the volume. • Set a correct sound system mode from the main menu to match your TV source.
No picture, or monochrome picture only.	<ul style="list-style-type: none"> • The colour system setting does not match the program. • The sound system setting does not match the program. 	<ul style="list-style-type: none"> • Select the appropriate colour system setting. • Select the appropriate sound system setting. (If unsure, use Auto settings where available).
Sound or picture interference.	<ul style="list-style-type: none"> • Some equipment that causes interference is close to the TV. • More than one device is plugged into the same power outlet. • An incorrect sound system mode is set. 	<ul style="list-style-type: none"> • Keep interference-causing equipment away from the TV. • Plug the power adaptor into another, separate power outlet. • Set a correct sound system mode from the main menu to match your TV source.
PVR recording failed, or "DISK NOT READY" is displayed.	<ul style="list-style-type: none"> • You may not have removed your USB device after the last recording, which is necessary to protect the device from damage. 	<ul style="list-style-type: none"> • Remove the USB device after each recording if you experience recording problems. If "DISK NOT READY" is displayed, remove the device, reconnect and then proceed with your recording.

Problem	Possible cause	Possible solution
DTV Picture Pixelation	• Poor Signal	<ul style="list-style-type: none"> • Adjust the position or orientation of the TV antenna. • Check the antenna connection from the wall plate to the TV. • Try re-tuning the channels as the channel frequencies may be different in some areas.

NOTE: Thank you for purchasing a Majestic quality TV. Our products have been designed with over 15 years of engineering excellence and are designed of the highest quality standard in the Marine and RV industry. Should you encounter any problems that cannot be easily addressed within this instruction manual please feel free to contact us at these locations:

Australia (Int'l Head Office): 073 102 3575
 New Zealand: 09 415 6936
 USA: 561 459 1900
 All other countries please email support@majestic-global.com

Feel free to visit our website for more updated specifications or technical support
www.majestic-global.com

IX. Specifications

Picture & Sound

MODEL	LED222GS
Screen Size	22"
Display Type	LED
Aspect Ratio	16:9
Panel Resolution (pixels)	1920 (H) x 1080 (V)
Brightness	250 cd/m2
Contrast Ratio	1000:1
Response Time	5ms
Speakers	2 x 3W
Viewing Angle	160(H) x 170(V)
HD Modes	480i, 480P, 575i, 576P, 720P, 1080i, 1080P
TV System	DVB-T2/S2/C, ATSC/NTSC
Sound System	B/G, I, D/K

Other Info

Dimensions - W/o Stand	505 x 311 x 45mm
Dimensions - With Stand	505 x 350 x 165mm
Wall Mounting	VESA 100 x 100
Weight	3.1kg
Voltage	DC12V --- 4A
Operating Temperature	0° - 35°C